

Pocket-Valve models '15-'29

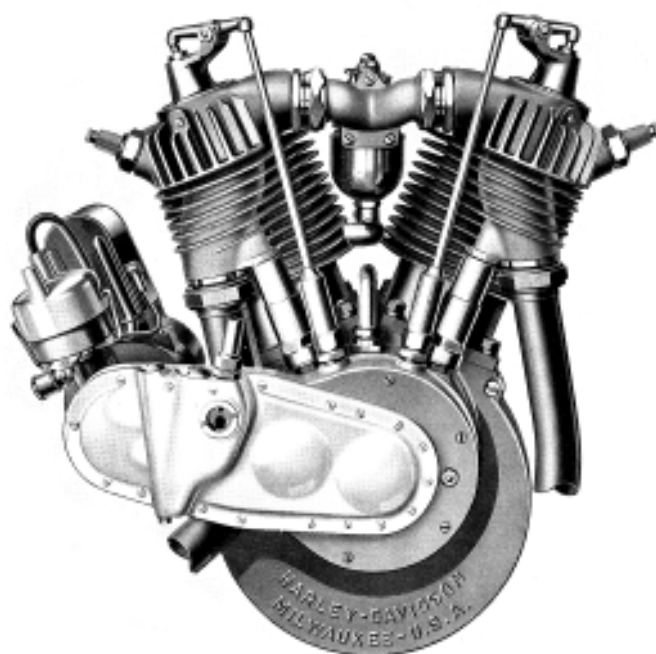

Jan Willem Boon

Meppelerweg 3
7963 RV Ruinen
The Netherlands

Phone: +31 (0)522-471177
jw@jwboon.com
www.jwboon.com

How to use this catalog:

Part number:
All numbers that begin with a letter (R, C) are reproduction parts, other numbers are original Harley parts (new old stock).

Price: €
Prices are in Euro's.
Prices include dutch sales-tax.
Sales-tax will be deducted on shipments outside the EU.
Dutch sales-tax is 21%, except books (9%).
"n.a." is "not available" (sold out)

Refers to letter in picture.
In this case you can choose between four part numbers.

A.	2326-38	Hex plug	'38-'51	park	n.a. ⚡
"	R2326-38P	Hex plug	'38-'51	park	7.50 ⚡
"	R2326-38	Hex plug	'38-'51	cad	7.50 ⚡
"	R2326-38C	Hex plug	'38-'51	chrome	10.63 ⚡
B.	C8115-1	Hex plug	'52-'73	cad	6.25 ⚡
"	C8114-1	Hex plug	'52-'73	chrome	9.38 ⚡

The little star ⚡ means the part was manufactured in the USA.
No star means not USA-made or we do not know. (we rely on information from our suppliers)

How to order:

You can order by phone, e-mail, or website form.

When ordering parts you need to give your name and address, and the list of part numbers you require. The part numbers are the bold printed numbers in this catalog.

You must use part numbers from this catalog, do not use Harley "oem" part numbers.

Payment and shipping depend on the size of the order, and to which country it is shipped.

You can find the cost for most common shipments on the website.

Minimum order: € 125.00

Jan Willem Boon

Meppelerweg 3
7963 RV Ruinen
The Netherlands

Phone: +31 (0)522-471177 9.00-17.00 weekdays
E-mail: jw@jwboon.com
Web: www.jwboon.com

mailorder only



Info:

Pictures in this catalog are for illustration purpose only, do not use for technical reference.

Most older paper gaskets need to be soaked in water for 10 minutes to regain their original size.

The Harley-Davidson part numbers are for reference only.

For up-to-date information check our on-line database:
www.jwboon.com

About nuts:

Early 1940's and earlier nuts were mostly manufactured by H-D and were machined from stock. These nuts are clearly different than the later style nuts.



See the "Bolts and Nuts" section in the back of this catalog for a complete list

Hex bolt head markings:

'41 and earlier bolts were usually made by Harley and were not marked (plain head). War-time production saw the arrival of other suppliers, these could be marked "1035 cp" or "1038cp"



See the "Bolts and Nuts" section in the back of this catalog for a complete list

Manuals	2	Fender parts	15
Spare parts catalogs	2	Mudflaps	15
Service manuals	2	Rear brake	16
Service department bulletins	2	Front brake	16
"The Enthusiast"	3	Battery box parts	17
Owner's manuals/riders handbooks	3	Wiring kit	17
Accessory catalogs	3	Horn switch	18
Miscellaneous books	4	Taillight lenses	18
Engine	7	Roller bearing roller guide	18
Connecting rod bearing	7	Relay	18
Rod bearing tools	7	Tools	19
Shafts and parts	8	Heli-Coil®	20
Exhaust	9	Taps and dies, special sizes	20
Model H carburetor parts	9	Taps, dies	21
De Luxe carburetor parts	9	Drills	21
Generator	10	Screws, bolts, nuts	22
Chain	10	Round head screws	22
Transmission	11	Fillister head screws	22
Fork springs	12	Oval countersunk head screws	22
Footboards	12	Hex head bolts	23
Seat post parts	12	Nuts	24
Handlebar parts	13	Washers	25
Handlebar spirals and parts	13	Lockwashers	26
Handlebar control cables	13	Steel balls	26
Petrol/oil tank parts	14	Rivets	26
Tank mounting screws	14	Special lockwashers	26
Tank transfers	14	Grease fittings	26
Oil & petrol lines	15	Cotter pins	26
Petrol valve	15	Standard hardware	27



Manuals

€ prices in euro

Spare Parts Catalogs

Essential information for restoring your Harley-Davidson.
Books 500 to 503 have photos, later books have exploded views.

L500	'13-'21 Twins	95 p.	16.00 ☼
L501A	'22-'28 all except opposed Twin	90 p.	12.00
L502	'28-'32 all models	105 p.	15.00
L516	'26-'39 all models	175 p.	20.00 ☼
L503	'30-'40 Twins	150 p.	22.00
L504	'37-'49 Big Twins	148 p.	15.00
L505	'40-'50 750cc civilian and Servi-car	124 p.	15.00
L541	'40-'43 WLA military models	124 p.	15.00
L506	'49-'57 Twins incl. Servi-car	156 p.	n.a.
L508	'58-'73 Servi-car	127 p.	16.00 ☼
L507A	'54-'65 KH, XLH, XLCH	106 p.	18.00 ☼
99451-80	'79-'80 Sportster	104 p.	45.00 ☼
L498	'48-'55 Lightweight models	52 p.	16.00 ☼
L499	'56-'65 Lightweight models	62 p.	16.00 ☼
L509A	'58-'68 Panhead/Shovel	149 p.	15.00 ☼
99455-80	'71-'80 FX	233 p.	45.00 ☼
99438-80	1980 FLT	104 p.	45.00 ☼
99438-82	'80-'82 FLT	141 p.	45.00 ☼



Service Manuals

L525	1928 Schebler Carburetor Manual	45 p.	16.00
L543	'41-'45 WLA Maintenance Manual	206 p.	16.00
This manual contains assembly, maintenance, organisational and test procedures for WLA or other 750cc models. Army #TM 9-879, use with overhaul manual L544 .			
L544	'41-'45 WLA Overhaul Manual	216 p.	16.00
Best manual available for all 750cc models '41-up. Army #TM 9-1879, use with L543 maintenance manual.			
L546	1942 Uncrating and Assembly	21 p.	7.50
WLA, full page photos.			
L547	1943 Motorcycle mechanics book	134 p.	20.00
WLA and XA. "The Armored School", Fort Knox.			
L548	WLC Service and operators manual	80 p.	14.00
L521	Service Manual '40-'47 Big Twins		15.00 ☼
99485-84	Sidecar Manual '79-'84 CLE/TLE		30.00 ☼
99483-80	Service Manual 1980 FLT		45.00 ☼
99483-81	Service Manual '80-'81 FLT		45.00 ☼
99498-77	Service Manual '77-'78 XLCR		85.00 ☼
L536	Service Manual '59-'66 Lightweights		17.00 ☼

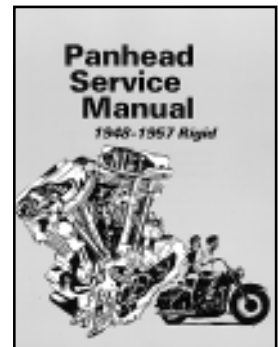

Service Department Bulletins (Shop Dope)

Collections of bulletins the factory sent to the dealers.

L530	Volume I	All models	'-'29	18.00 ☼
L531	Volume II	All models	'30-'40	18.00 ☼
L532	Volume III	All models	'41-'56	18.00 ☼
L533	Volume IV	All models	'56-'69	27.00 ☼

prices
in euro €



Manuals

Owner's Manuals / Riders Handbooks

Includes wiring diagram, lubricating instructions, adjustments, etc.

L561	1926	Singles	36 p.	n.a.
L562	1929	'20's Pocket-valves	63 p.	9.00
(includes supplement covering '15-'29 models)				
L563	1935	750cc (R models)	40 p.	9.00 ☉
L587	1936	VL models	40 p.	n.a.
L545	'43	WLC, also WLA and WL	36 p.	9.00
L565C	1950	Panhead	54 p.	11.00 ☉
L565A	1955	Panhead	68 p.	11.00 ☉
L565B	'58-'64	Panhead	60 p.	11.00 ☉
99460-76	1976	FL, FX	70 p.	15.00 ☉
99460-77	1977	FL, FX	72 p.	15.00 ☉
99460-78	1978	FL, FX	76 p.	15.00 ☉
99460-78E	1978½	FL, FX	80 p.	15.00 ☉
99460-79	1979	FL, FX	80 p.	15.00 ☉
99466-72	1972	Sportster	60 p.	20.00 ☉
99466-74	1974	Sportster	60 p.	17.00 ☉
99466-75	1975	Sportster	60 p.	15.00 ☉
99466-76	1976	Sportster	60 p.	15.00 ☉
99466-77	1977	Sportster	64 p.	15.00 ☉
99468-77	1977	XLCR	56 p.	20.00 ☉
99466-78	1978	Sportster	64 p.	15.00 ☉
99465-81	1981	FLT	118 p.	20.00 ☉

Accessory Catalogs

Showing all accessories available that year, including buddy-seats, saddlebags mirrors, spotlights, wind screens, lap aprons, air cleaners, clothing, hats, badges, police accessories, tools, special workshop tools, goggles, etc, etc.

L550	1918-1919	94 p.	16.00
L552	1934	32 p.	12.00 ☉
L553	1936	32 p.	9.00
L554	1941	72 p.	15.00 ☉
L555	1947	69 p.	15.00
L556	1957	60 p.	15.00 ☉
L557	1960	30 p.	15.00 ☉

"The Enthusiast"

Every year, usually late summer, the new models were announced in "The Enthusiast". Now you have an opportunity to buy the issue that announced your Harley, 1924 to 1958, barring World War II years. These Enthusiasts are also fascinating period magazines often with articles, letters and pictures from all over the world, technical hints, race reports, police department news, etc.

Quality reprints, 21½ x 14 cm., about 24 pages.

L151	1924 models	L168	1941 models
L152	1925 models	L169	1947 models
L153	1926 models	L170	1948 models
L154	1927 models	L171	not available
L155	1928 models	L172	1950 models
L156	1929 models	L173	1951 models
L157	1930 models	L174	1952 models
L158	1931 models	L175	1953 models
L159	1932 models	L176	1954 models
L160	1933 models	L177	1955 models
L161	1934 models	L178	1956 models
L162	1935 models	L179	1957 models
L163	not available	L180	not available
L164	1937 models		
L165	1938 models		
L166	1939 models		
L167	1940 models		

Military Editions

L181	October 1942
L182	not available



	1 copy	9.00 ☉
L150	6 copies	32.00 ☉
L149	12 copies	60.00 ☉

L590	1916 Sales Brochure	24 p.	n.a.
L591	1917 Sales Brochure	5 p.	3.00
L534	1950 WR/WRTT sales brochure	4 p.	7.00

Miscellaneous Books

“At The Creation”

by Herbert Wagner

For good reason the origin period of the Harley-Davidson motorcycle has been called an “era of mystery”. Not only were Harley-Davidson’s origins poorly recorded, but the company’s beginnings were further obscured by later confused and contradictory claims that developed into myths. In this work, Herbert Wagner examines several long-standing puzzles and unanswered questions. This book is the definitive account of the beginnings of the only surviving American motorcycle brand.

L686 At the creation 228 pages 45.00

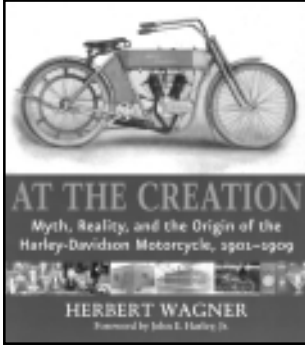

“Cross Index of Harley-Davidson Part Numbers”

Parts catalogs from 1950 and earlier use the “old” part numbers, 1951 and later parts catalogs use the “new” parts numbers. This manual is a cross-index between the old and new numbers.

L593 Cross index of H-D part numbers 53 pages 18.00

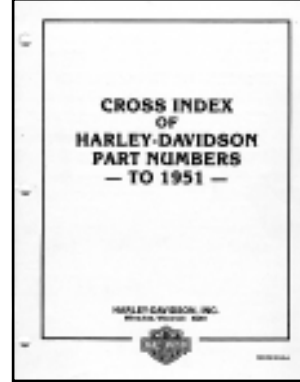

“Harley-Davidson Flatheads”

by Jerry Hatfield

One of the most versatile motorcycles ever built, the Flathead anchors the Harley-Davidson lineage. Flathead engines powered The Motor Company’s success in the 1930s when a fourth of all workers were laid off, and were the Army’s “weapon of choice” during World War II. Author Jerry Hatfield chronicles 55 years of the type’s engineering, military service, racing adventures, and sales success. Restorers will find this book indispensable, but any H-D enthusiast will enjoy this colorful fact-filled account of The Motor Company’s jack-of-all-trades, the Flathead.

L645 Flatheads 128 pages 26.00

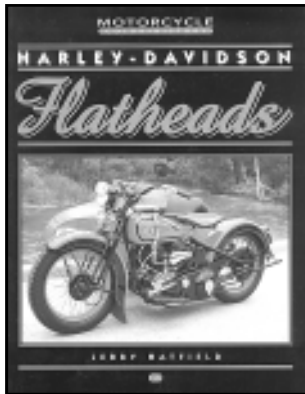

“The Big Book Of Harley-Davidson”

by Thomas C. Bolfert 1996 edition

Beautiful hard cover, full color, large size book, 10" x 12½" / 25 x 32 cm, 300 pages

Follow the trail of this American success story as it winds through history, decade by decade, influenced by wars, depressions, and severe competition from domestic and foreign sources, only to emerge in the 1990’s stronger and more popular than ever. Told in an easy narrative style, and illustrated by over a thousand colorful photos dating back to the turn of the century, the story of Harley-Davidson is fitted against a historical timeline that helps put its long past into the proper perspective of the prevailing times.

L619 Big Book of H-D 300 pages 70.00



“Growing Up Harley-Davidson”

by Jean Davidson

This memoir of the Harley-Davidson motorcycling dynasty contains rare photos from the family album, as well as the inside scoop on the behind-the-boardroom-door politics and corporate battles, adding new tales to fuel the myth behind one of the world’s great pop culture icons. All copies autographed by Jean Davidson.

L687 Growing up H-D 270 pages hard cover 20.00

L688 Growing up H-D limited edition paperback 25.00

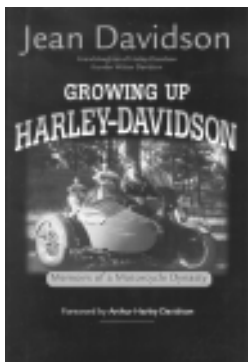

“H-D Classics 1903-1965”

-Illustrated Buyer’s Guide-
by Jerry Hatfield

Harley-Davidson was synonymous with raw power and speed in the early days of motorcycling. Those tremendous machines are chronicled here, from the early singles to the Panhead Big Twins and Sportsters. Each bike is covered year by year, with ratings for collectibility, smoothness of ride, passenger accommodations, reliability, and parts and service availability. This formidable group of data is supplanted with the author’s riding impressions, which put you in the driver’s seat of dozens of collectible Harley-Davidson motorcycles. With this comprehensive book, you’ll be well-equipped to select the year and model perfect for your needs, whether it is a 1914 Twin with sidecar, 1941 WLD, 1936 Model EL Knucklehead, or 1957 Sportster.

L639 Buyer’s Guide 1903-1965 192 pages 20.00

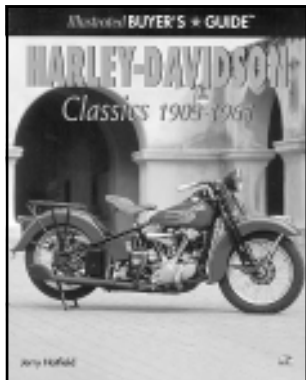

“Motorcycle Memorabilia”

by Roger Pribbenow.

Motorcycle Memorabilia is an enjoyable look at the sport of motorcycling from its beginning around 1900 to the mid-1960’s. Photographed in full color are a great variety of items illustrating the scope of memorabilia collecting and items available to the collector. From catalogs and brochures to motorcycle toys and clothing, manufacturers pins and oil containers, you’ll find it all here. Covers all American-made motorcycles.

L647 Motorcycle Memorabilia 78 pages 18.00



“Classic H-D 1903-1941”

by Herbert Wagner

Delving into the depths of Harley-Davidson history, author Herbert Wagner brings readers many new discoveries on the evolution of the Harley-Davidson Motorcycle. From the turn-of-the-century single-cylinder prototype to the 1941 74 OHV Big Twin Knucklehead, *Classic Harley-Davidson 1903-1941* captures the dream of Bill Harley and the Davidson brothers. Over 80 color photographs help illustrate this amazing story, depicting such models as: 1903 to 1905 Singles - Early V-twins, World War I military models, JDH and JH models (two-cam)- 21" and 45" OHV models - VL and VLH Flatheads - EL and FL Knuckleheads

L644 Classic H-D 1903-1941 96 pages 18.00

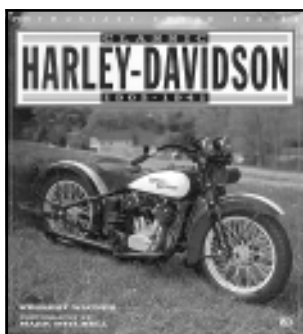

“Harley-Davidson in the 1960s”

by Allan Girdler & Jeff Hackett.

“Harley-Davidson in the 1960s” chronicles The Motor Company’s efforts to survive the Asian onslaught, a struggle that transforms Harley-Davidson-a family run business concern-into a division of AMF. In the process it tells the story of some of the most exciting motorcycles of all time. Covers all models; Duo-Glide, Early-Shovel, Sportster, KR-TT racer, Sprint, Topper scooter, etc.

L655 H-D in the 1960’s 95 pages 16.50

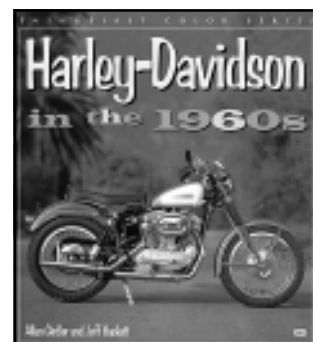

"The H-D Motor Co. - Archive Collection"

by Randy Leffingwell and Darwin Holmstrom
Since its earliest days, the Harley-Davidson Motor Co. has saved examples of nearly every motorcycle it has ever built. In over 600 studio portraits, Harley-Davidson and master photographer Randy Leffingwell present this historically significant collection of production models, racing bikes, and one-of-a-kind prototypes.

L679 Archive Collection 408 pages 26.00



"This Old Harley"

by Michael Dregni
This Old Harley captures just what it is about Harleys that makes them so popular. This anthology is a tribute not only to this legendary piece of American automotive machinery, but also to the stories, histories, and lifestyles behind its rise as the world's most popular motorcycle.

L673 This old Harley 160 pages 26.00

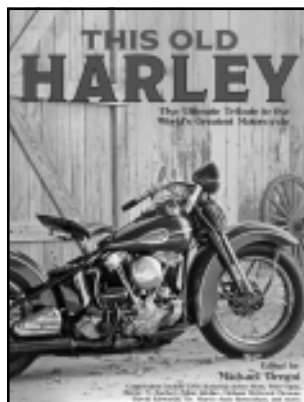

"Harley-Davidson Family Memories"

by Jean Davidson, Jon Davidson Oeflein

L676 Family Memories 168 pages hard cover 33.00



"Harley and the Davidsons"

by Pete Barnes
A short history of the Harley-Davidson company, written for young readers.

L680 Harley and the Davidsons 106 pages 13.50

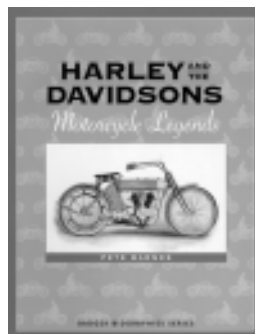

"Museum Masterpieces"

by Dain Gingerelli
- 51 bikes featured
- over 250 color photos
- performance and production specs
- historical facts and trivia about each bike

L675 240 pages 22.00



"The Harley in the Barn"

by Tom Cotter
The Harley in the barn offers 40-plus tales of lost Nortons, hidden Harleys, dormant Indians, and busted BSA's, all squirreled away from prying eyes but found by lucky collectors just like you.

L683 256 pages hard cover 24.00



"kids Books"

by Jean Davidson

L677 "My daddy makes the best..." (autographed) 24.00

L678 "Riding back in time" (autographed) 24.00

L684 Coloring book 7.00

L685 Activity book 7.00

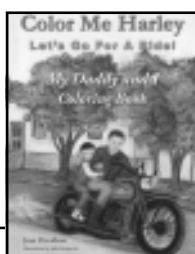
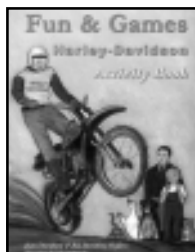

"The Encyclopedia of the Harley-Davidson"

by Peter Henshaw & Ian Kerr
The world's most famous motorcycle manufacturer is celebrated in this comprehensive guide, from its humble beginnings to the successful company it is today.

L681 The encyclopedia of H-D 442 pages hard cover 23.00

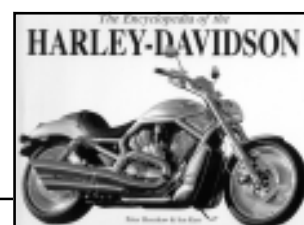

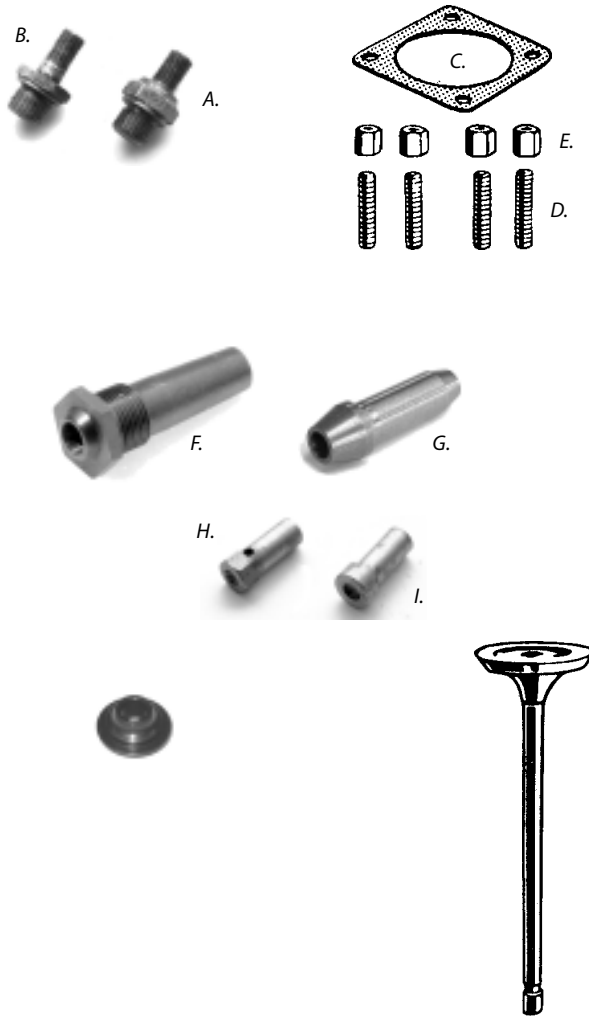

A.	17-20	Cylinder plug	'20-'24 61" models	32.00 ☉
B.	18-25	Cylinder plug	'25-'28 74" models	n.a. ☉
	27-25	Eccentric washer, cylinder plug	'25-'29	n.a. ☉
C.	R46-21	Gasket, cylinder base	61" models '24-'29, 74" models '21-'29	2.50 ☉
"	R46-21-X	Gasket, cylinder base	rubber metal base	21.00 ☉
D.	R29-09	Stud, cylinder base		4.00 ☉
"	R29-09P	Stud, cylinder base	park	4.00 ☉
E.	R0120P	Nut, cylinder base	park	1.44 ☉
"	R0120	Nut, cylinder base	cad	1.50 ☉
"	R0120C	Nut, cylinder base	chrome	1.69 ☉
"	R0120NI	Nut, cylinder base	Nickle	1.75 ☉

R90-15set	Inlet housings (2)	'15-'16 models	250.00
R90-17set	Inlet housings (2)	61" models '17-'29, FD, JD models '21-'24	n.a.
R91-23set	Inlet housings (2)	DCA, DCB motors '23-'24, Std. 74" motors '25-'29	n.a.
<i>(order additional spring seat to use these on '28-'29 H motors)</i>			

F.	R95-17S	Inlet valve guide, undersize	61" models '17-'29, FD, JD models '21-'24	n.a.
G.	R95-23	Inlet valve guide	'23-'24 DCA & DCB motors, '25-'29 standard 74", '28-'29 L motors	15.00

R116-17	Inlet valve	F, J '17-'29 - FD, JD '21-'24	17.00
R117-23	Inlet valve	FD, JD '25-'29	17.00
R119-23	Spring, inlet valve	'23-'29	8.50 ☉
R180-15	Exhaust valve	F, J '15-'23	20.00
R181-21	Exhaust valve	JD '21-'29	20.00
R186-10S	Spring, exhaust valve		5.00
R188-08	Collar, exhaust valve	'11-'29	9.00 ☉

Connecting Rod Bearing, '15-'29

N.	CRR-KZK	Set of rod races (3) (Timken bearing steel)		180.00 ☉
P.	305-15.12pack	Roller, standard	0.2498" x .726"	17.50 ☉
"	R305-15	Roller, standard	0.2498" x .726"	1.00 ☉
"	R305-15D	Roller, oversize	+ .0002"	0.60 ☉
"	R305-15F	Roller, oversize	+ .0004"	0.60 ☉
"	R305-15H	Roller, oversize	+ .0006"	0.60 ☉
"	R305-15KA	Roller, oversize	+ .0008"	0.60 ☉
"	R305-15MA	Roller, oversize	+ .0010"	0.60 ☉
R.	R304-15	Roller, standard	0.2498" x .360"	n.a.
"	R304-15D	Roller, oversize	+ .0002"	0.60
"	R304-15F	Roller, oversize	+ .0004"	0.60
"	304-15H	Roller, oversize	+ .0006"	1.00 ☉
"	R304-15H	Roller, oversize	+ .0006"	0.60
"	304-15KA	Roller, oversize	+ .0008"	1.00 ☉
"	R304-15KA	Roller, oversize	+ .0008"	0.60
"	304-15MA	Roller, oversize	+ .0010"	n.a.

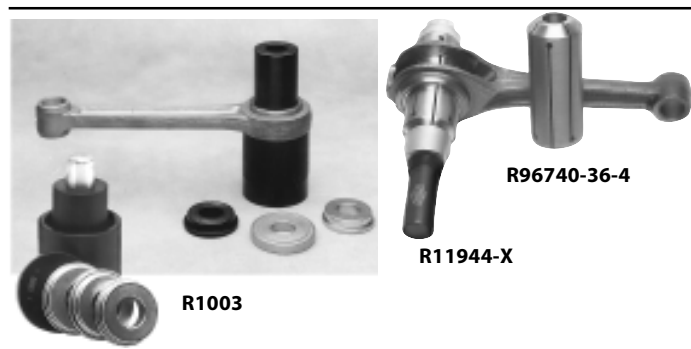
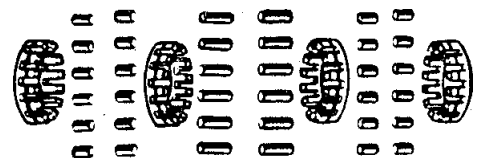

Rod Bearing Tools

R1003	Rod race removal & installation tool		285.00 ☉
Complete kit, includes collars for use on all Big Twin, 750cc and Sportster connecting rods.			
R11944-X	Rod lapping arbor	1-1/2"	357.50 ☉
R96740-36-4	Replacement lap head	1-1/2"	180.00 ☉
R96740-36	Rod lapping set		537.50 ☉
Includes 1-1/2" & 1-5/8" lap to lap all connecting rod races from 1915 and later.			

Engine

Shafts and Parts

	AA-711	Crank pin	'13-'14	120.00 ✪
A.	R348-15	Crank pin (Jims)	'15-'29	165.00 ✪
	R348-30	Crank pin (Eastern)	'15-'29	95.00 ✪
B.	R365-15	Nut, crank pin	'15-'29	11.56 ✪
	R352-17	Sprocket shaft	'17-'24	95.00 ✪
	R352-25	Sprocket shaft	'25-'29	95.00 ✪
D.	R355-15	Gear shaft	'15-'29	145.00 ✪
E.	R361-12	Key, shafts	'12-'29	2.75 ✪
F.	368-12	Lockwasher, shaft nut	'12-'29	2.50 ✪
"	R368-12	Lockwasher, shaft nut	'12-'29	1.60 ✪
G.	R030Z	Screw, lockwasher	'12-'29	0.30 ✪



A.

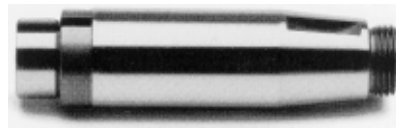

D.

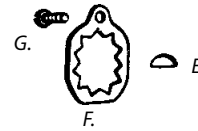

I.	R304-15	Roller, standard	0.2498"	n.a.
"	R304-15D	Roller, oversize	+0.002"	0.60
"	R304-15F	Roller, oversize	+0.004"	0.60
"	304-15H	Roller, oversize	+0.006"	1.00 ✪
"	R304-15H	Roller, oversize	+0.006"	0.60
"	304-15KA	Roller, oversize	+0.008"	1.00 ✪
"	R304-15KA	Roller, oversize	+0.008"	0.60
"	304-15MA	Roller, oversize	+0.010"	n.a.
	R413-15	Bushing, right crankcase	'15-'29	43.00 ✪



R413-15

Flywheel washers (pressed in flywheels).

J.	372-21	Washer std. .055" (1,39 mm)	'21-'29	10.00 ✪
"	R372-21	Washer std. .055" (1,39 mm)	'21-'29	7.00 ✪
"	R372-21B	Washer o.s. .060" (1,52 mm)	'21-'29	8.50 ✪
"	R372-21C	Washer o.s. .067" (1,70 mm)	'21-'29	9.00 ✪
K.	R358-17A	Set sprocket shaft collars (11)	'17-'29 (.060" to .110" except .094")	21.50 ✪



J.

K.

	R451-09	Nut, case studs	cad	'11-'29	3.75 ✪
	R451-09NI	Nut, case studs	Nickle	'11-'29	4.06 ✪
	C8628-6	Set of 6 case nuts	cad	'11-'29	21.25 ✪
	C2952-6	Set of 6 case nuts	Nickle	'11-'29	22.50 ✪
	C8629-1	Nut driver tool		'11-'29	17.50 ✪
	C2594-1	Nut driver tool with T-handle		'11-'29	28.75 ✪



C8628-6



C8629-1

	R453-10A	Casing drain plug, slotted	cad	7.50 ✪	
M.	453-11	Casing drain plug	park	'11-'29	6.00 ✪
"	R453-11P	Casing drain plug	park	'11-'29	4.38 ✪
"	R453-11	Casing drain plug	cad	'11-'29	4.38 ✪
"	R453-11C	Casing drain plug	chrome	'11-'29	6.25 ✪

Note: 453-11 dain plugs do not have slotted heads.



R453-10A



R453-11

	R453-11SP	Drain plug, oversize 7/16-20	park	6.25 ✪
	R453-11S	Drain plug, oversize 7/16-20	cad	6.25 ✪
	R453-11SC	Drain plug, oversize 7/16-20	chrome	6.88 ✪

N.	462-11	Washer, secondary gear stud	'11-'29	0.50 ✪
"	R462-11	Washer, secondary gear stud	'11-'29	0.30
	640-22	Generator gear stud 1-1/8" late	'22-'28	29.00 ✪

O.	R658-15	Spring ring, small gear stud	'15-'29	0.60 ✪
P.	R524-25	Spring, release lever	'25-'29	1.20
R.	R634-15	Key, magneto/generator gear	'15-'29	0.80 ✪



N.



O.



R.

	R021P	Screw, gear cover	park	0.63
	R021	Screw, gear cover	cad	0.63
	R021Z	Screw, gear cover	zinc	0.30
	R021C	Screw, gear cover	chrome	0.60
	R021NI	Screw, gear cover	Nickle	0.88

AA-31	Exhaust pipe	Singles	'10-'14	95.00 ☼
B. R1004-15	Pipe set (2 pcs)	bare	'15-'24	110.00 ☼
C. R1004-25	Pipe set (2 pcs)	bare	'25-'29	105.00 ☼
D. R1012-21	Exhaust pipe nipple	Nickle		56.25 ☼
			74" models '21-'29, also '28-'29 61" L-motors.	
E. R1014-21	Exhaust pipe nut	Nickle		33.75 ☼
			74" models '21-'29, 61" models '25-'29	

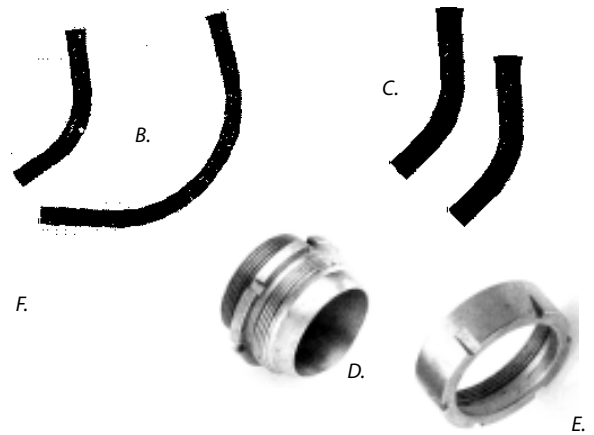

R1112-17	Intake nipple	'17-'23	Nickle	33.75 ☼
R1125-15	Gasket, intake nipple	'17-'23		4.69 ☼
R1112-23	Intake nipple	'23-'29	Nickle	35.31 ☼
R1125-23	Gasket, intake nipple	'23-'29		5.00 ☼



R1115-15	Nut, intake manifold	'15-'27	Nickle	21.56 ☼
R1115-23	Nut, intake manifold	'23-'29	Nickle	21.88 ☼

R1118-15	Bushing, intake manifold			n.a.
F. 1121-21	Gasket, manifold	74" '21-'29, 61" '24-'29		0.50



C2420-3	Manifold screws (3)	'15-'23 J 61"		13.75 ☼
C2421-3	Manifold screws (3)	'21-'23 JD, '24-'29 J, JD		13.75 ☼

Model H carburetor parts

G. R1152-11	Screw, needle adjusting	'11-'27		8.50
" R1152-11cad	Screw, needle adjusting	'11-'27		12.50 ☼
H. R1153-11	Lockscrew, needle valve	'11-'27		0.40 ☼
I. R1154-11	Lockspring, needle valve	'11-'27		2.00

J. R1196-11kit	Pin and screw, float lever	'29-'58		12.50 ☼
K. 1197-16	Screw only	'16-'27		5.00 ☼
" R1197-16	Screw only	'16-'27		4.38 ☼

1141-14	Bushing, air valve shaft	61" '14-'23		n.a. ☼
1145-11	Air valve spring	61" '11-'23		n.a. ☼
1145-21	Air valve spring	74" '21-'23		n.a. ☼

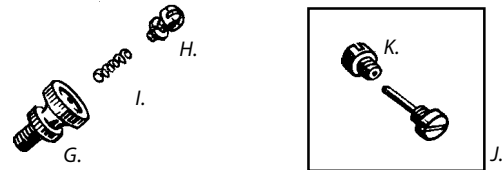

De Luxe carburetor parts

L. 1232-24	Disc, air intake	'24-'29		n.a.
M. R010Z	Screw, air intake shaft	'24-'29		0.30
N. R1234-24	Screw, intake lever park	'24-'29		4.20
O. R1243-24	Throttle shaft	'24-'29		14.00
P. 1244-24	Throttle disc	'24-'29		13.00 ☼
M. R010Z	Screw, throttle shaft	'24-'29		0.30
Z. R1245-24	Bushing, throttle shaft	'24-'29		3.00 ☼

ZB. R1261-27A	Low speed needle cpt.	'27-'29		28.75 ☼
R. R1262-27	Collar, spring	'27-'29		3.00
S. 1263-24	Drill plug	'24-'29		3.00 ☼
" R1263-24	Drill plug	'24-'29		2.20
T. 1264-27	Spring, needle valve	'27-'29		n.a. ☼
" R1264-27	Spring, needle valve	'27-'29		0.80 ☼

U. R1254-27	High speed needle valve	'27-'29		33.75 ☼
V. R1254-27S	High speed needle valve, longer thread			n.a.

This needle has extra long threads to be used when first part of thread in carburetor body is damaged. Clean up threads with 1/4"-40 tap first.

G. R1152-11	Screw, needle adjusting	'27-'29		8.50
" R1152-11cad	Screw, needle adjusting	'11-'27		12.50 ☼
H. R1153-11	Lockscrew, needle valve	'27-'29		0.40
I. R1154-11	Lockspring, needle valve	'27-'29		2.00
R1268-24	Nut, carburetor bowl	'24-'28		n.a.
W. R1269-28	Gasket, bowl lock nut	'28-'29		2.06 ☼
J. R1196-11kit	Pin and screw, float lever	'29-'58		12.50 ☼
K. 1197-16	Screw only	'24-'29		5.00 ☼
" R1197-16	Screw only	'16-'27		4.38 ☼
Y. 1293-27	Screw, needle valve lever	'27-'29		6.00 ☼
" R1293-27	Screw, needle valve lever	'27-'29		3.00 ☼

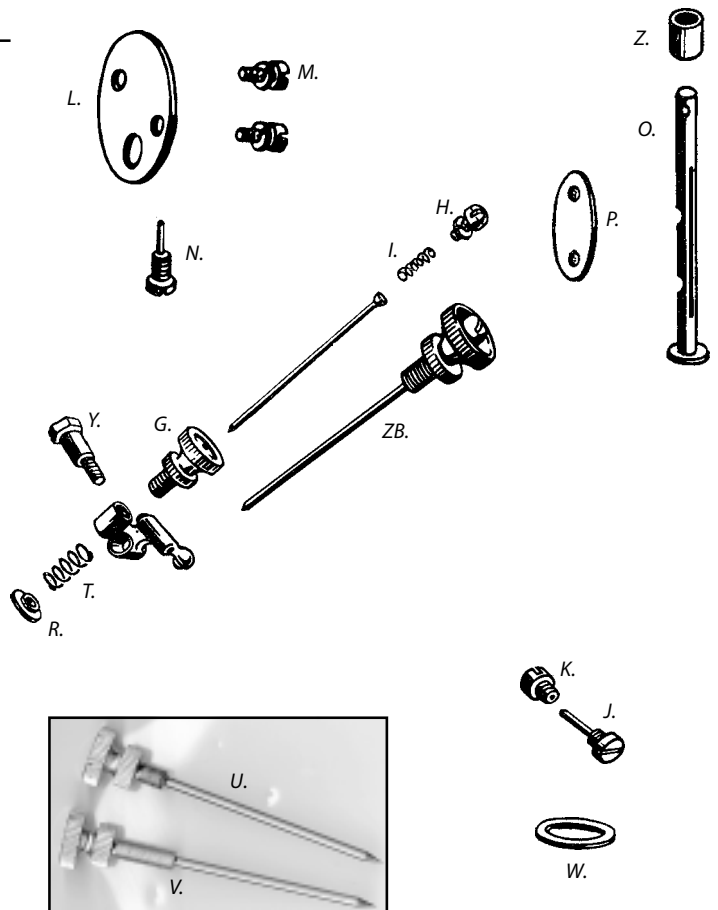

Generator

A.	1512-18E	Screw, pole piece	'18-'29	3.00 ✪
"	R1512-18	Screw, pole piece	'18-'29	2.06 ✪
	R070P	Bolt, fastening park	'18-'29	3.38 ✪
	R070	Bolt, fastening cad	'18-'29	3.44 ✪
	R070C	Bolt, fastening chrome	'18-'29	1.40 ✪
A.	1512-18E	Screw, right end plate	'18-'29	3.00 ✪
"	R1512-18	Screw, right end plate	'18-'29	2.06 ✪
C.	1614-18	Terminal, low tension wire	'18-'29	3.00 ✪
D.	R1644-18	Bearing, armature	'18-'29	10.00
E.	1650-18	Key, worm gear	'18-'29	2.00 ✪
F.	R634-15	Key, drive gear	'15-'29	0.80
	1671-24	Small brush & holder	'24-'25	28.00 ✪
	1674-24	Brush holder spring	'24-'25	15.00 ✪
G.	R1674-26	Spring, brush	'26-'29	1.00
	R036	Screw, brush plate cad	'26-'29	0.69
	1598-27	Terminal, spark plug; hollow tube		4.00 ✪
	R1599-27	Washer rubber seal	'27-'59	2.50 ✪
	R1599-27A	Packing nut cad	'27-'59	8.75 ✪
	R0211P	Washer park	'27-'59	0.63 ✪
	C7804-6	Set nuts & washers cad	'27-'59	22.50 ✪

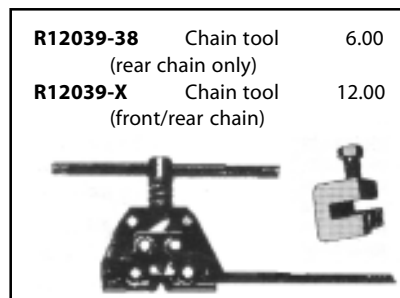
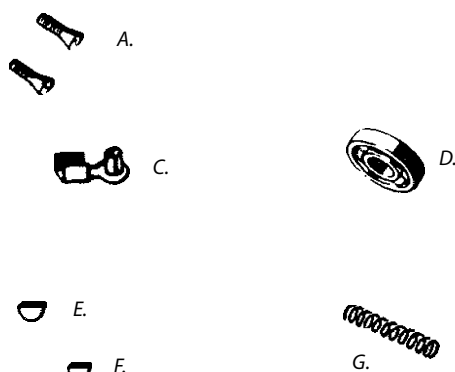

	R2003-102	Chain 3/8" x 5/8" 102 links		65.00 ✪
	R2003-106	Chain 3/8" x 5/8" 106 links		50.00 ✪
	R2003-110	Chain 3/8" x 5/8" 110 links		75.00 ✪
		(complete with connecting link)		
H.	2006-15	Link, connecting Diamond		3.00 ✪
I.	2012-15	Link, offset repair Diamond		6.00 ✪
J.	2015-15	Link, double repair Duckworth		5.00 ✪
K.	2050-12	Nut, motor sprocket 5/8" -18	'12-'29	7.00 ✪
L.	R361-12	Key, motor sprocket	'12-'29	2.75 ✪

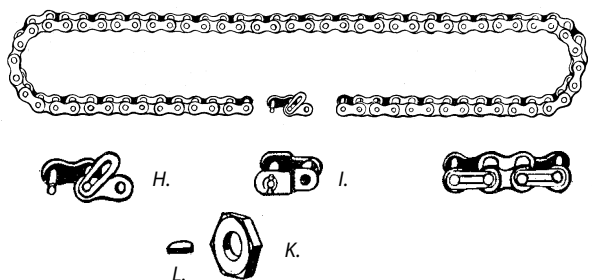

M.	R2080-16	Lockwasher, starter crank	'16-'29	1.15
N.	2084-24	Spring, starter crank	'24-'29	n.a. ✪
O.	R2092-16C	Starter pedal, bicycle type	'16-'29	n.a.
		(chrome with black rubbers)		
P.	R2092-17	Rubber, pedal black	'17-'29	10.00 ✪
"	R2092-17BL	Rubber, pedal blue	'17-'29	5.00 ✪
"	R2092-17G	Rubber, pedal green	'17-'29	5.00 ✪
"	R2092-17R	Rubber, pedal red	'17-'29	5.00 ✪
"	R2092-17W	Rubber, pedal white	'17-'29	n.a.
	R2093-17P	Rod, pedal rubber park		10.00 ✪
	R2093-17	Rod, pedal rubber cad		10.00 ✪
R.	R0104P	Nut, pedal rod park	'17-'29	0.50 ✪
"	R0104C	Nut, pedal rod chrome	'17-'29	0.75 ✪
"	R0104	Nut, pedal rod cad	'17-'29	0.50 ✪
Z.	R2095-16	Pedal axle park		30.00 ✪
ZA.	R2096-17P	Cover, pedal axle park		8.13 ✪
"	R2096-17	Cover, pedal axle cad		8.13 ✪
	R2099-29P	End cover park	'29	12.50 ✪
	R2099-29	End cover cad	'29	12.50 ✪
S.	R0224P	Washer, pedal axle park		0.63 ✪
T.	R0261P	Lockwasher park		0.25 ✪
U.	0129	Nut, pedal axle park		1.50 ✪
"	R0129P	Nut, pedal axle park		1.44 ✪
V.	2100-16	Bolt, pedal to crank park		8.00 ✪
"	R2100-16C	Bolt, pedal to crank chrome		9.38 ✪

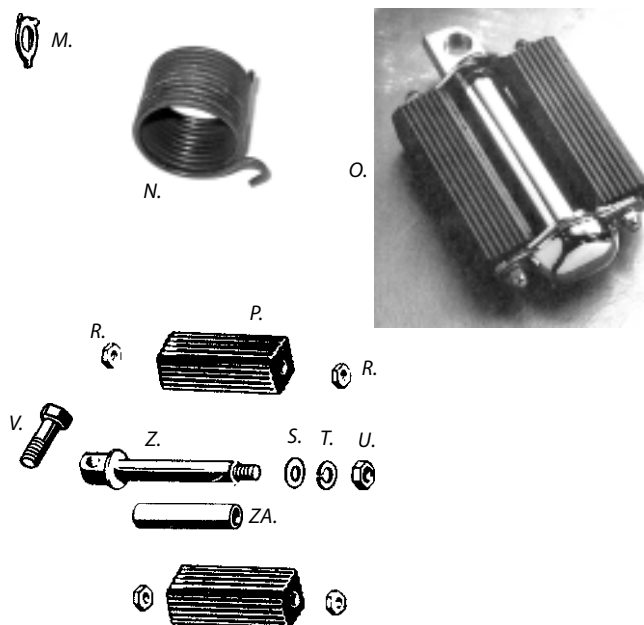

Transmission cover mounting kits

	C2377-36	Transmission top cover kit	Nickel	54.38 ✪
	C2379-36	Transmission top cover kit	park	50.00 ✪
	C2381-24	Transmission side cover kit	Nickel	35.00 ✪
	C2382-24	Transmission side cover kit	park	33.75 ✪





	R2206-16	Stud, shifter lever	Nickle	'16-'29	18.12 ☺
	R2206-16cad	Stud, shifter lever	cad	'16-'29	18.12 ☺
A.	R2210-16C	Nut, shifter guide	chrome	'16-'29	17.50 ☺
"	R2210-16NI	Nut, shifter guide	Nickle	'16-'29	16.25 ☺
	R2212-25	Shifter rod		'25-'29	n.a. ☺
B.	R4068-14	Shifter rod end	cad	'25-'29	21.88 ☺
C.	R0125P	Nut, shifter shaft	park	'15-'29	1.50 ☺
	C2678-2	Grease tube with nipple		'25-'29	19.69 ☺

	R0140	Nut, air vent tube	cad	'16-'28	3.75 ☺
	R0112P	Nut, cover stud	park	'16-'29	1.25 ☺
	R0112	Nut, cover stud	cad	'16-'29	1.38 ☺
	R0112NI	Nut, cover stud	Nickle	'16-'29	1.50 ☺
	R0213P	Washer, stud nut	park	'16-'29	0.50 ☺
	R0213NI	Washer, stud nut	Nickle	'16-'29	0.63 ☺

H.	R2287-17	Spring washer		'17-'29	3.00 ☺
J.	R2288-17	Plate, roller bearing		'17-'29	8.00 ☺

K.	R2289-17	Bearing roller	0.2498" x .270"	'17-'24	n.a. ☺
"	R2289-17D	Bearing roller	+0.0002"	'17-'24	0.50 ☺
"	R2289-17F	Bearing roller	+0.0004"	'17-'24	0.50 ☺
"	R2289-17H	Bearing roller	+0.0006"	'17-'24	0.50 ☺
"	R2289-17KA	Bearing roller	+0.0008"	'17-'24	0.50 ☺
"	R2289-17MA	Bearing roller	+0.0010"	'17-'24	0.50 ☺
"	R2289-17Q	Bearing roller	- .0002" undersize		0.50

L.	R2289-25	Bearing roller	0.2498" x .490"	'25-'29	0.50 ☺
"	R9219	Bearing roller	+0.0001"	'25-'29	0.50 ☺
"	R2289-25D	Bearing roller	+0.0002"	'25-'29	0.50 ☺
"	R9218	Bearing roller	+0.0003"	'25-'29	0.50 ☺
"	R2289-25F	Bearing roller	+0.0004"	'25-'29	0.50 ☺
"	R9217	Bearing roller	+0.0005"	'25-'29	0.50 ☺
"	R2289-25H	Bearing roller	+0.0006"	'25-'29	0.50 ☺
"	R2289-25KA	Bearing roller	+0.0008"	'25-'29	0.50 ☺
"	R2289-25MA	Bearing roller	+0.0010"	'25-'29	0.50 ☺
"	R2289-25MA2	Bearing roller	+0.0020"	'25-'29	0.50 ☺

	R2132-26	Gasket, side cover			3.00 ☺
	R2261-15	Gasket, top cover			1.50 ☺
M.	R2163-15	Oil retainer, small		'15-'29	17.00 ☺
N.	R2294-15	Oil retainer, large		'15-'29	18.00 ☺

O.	R2300-16	Countershaft		'16-'29	n.a.
P.	R2308-16set	Set end play washers (includes 7 washers; .076"-.100")		'16-'29	35.00 ☺
R.	R2309-16	Collar, countershaft bearing		'16-'29	4.50 ☺

K.	R2289-17	Bearing roller	0.2498" x .270"	'17-'29	n.a. ☺
"	R2289-17D	Bearing roller	+0.0002"	'17-'29	0.50 ☺
"	R2289-17F	Bearing roller	+0.0004"	'17-'29	0.50 ☺
"	R2289-17H	Bearing roller	+0.0006"	'17-'29	0.50 ☺
"	R2289-17KA	Bearing roller	+0.0008"	'17-'29	0.50 ☺
"	R2289-17MA	Bearing roller	+0.0010"	'17-'29	0.50 ☺
"	R2289-17Q	Bearing roller	- .0002" undersize		0.50

S.	R2312-16	Mounting collar, left	std.	'16-'29	22.00 ☺
"	R2312-16B	Mounting collar, left	+0.002"	'16-'29	23.00 ☺
"	R2312-16C	Mounting collar, left	+0.005"	'16-'29	24.00 ☺

	R2318-15	Stud, transmission bottom		'15-'29	5.31 ☺
	R0125P	Nut, mounting stud	park	'15-'29	1.50 ☺
T.	R453-10A	Drain plug, transmission		'25-'29	7.50 ☺
	R2326-17	Oil filler plug		'17-'29	15.00 ☺
	R2326-17keep	Oil filler plug "keep filled"		'17-'29	15.63 ☺
U.	R2328-25	Screw, gear box adjuster		'25-'29	18.75 ☺
	R2335-15	Mainshaft locknut		'15-'29	15.63 ☺
W.	R4068-14	Clutch rod end	cad	'14-'29	21.88 ☺
	R0125P	Nut, clutch pull rod	park	'15-'29	1.50 ☺
	R2470-15	Key, clutch		'15-'29	1.50
Y.	R2511-12	Clutch springs (set of 6)		'12-'14	21.00 ☺
"	R2511-15	Clutch springs (set of 6)		'15-'29	21.00 ☺



Bearing rollers also available in 100-packs

Fork / Footboards / Seat

Fork Springs

Fork springs are sold each.

R2615-09	Lower	18"	'12-'22 61" + '21 74"	20.00
R2617-13	Upper	6-1/2"	'13-'19 61"	n.a.
R2617-20	Upper	9-1/4"	'20-'22 61" + '21 74"	n.a.
R2615-22	Lower	20"	'23-'24 61" + '22-'24 74"	30.00
R2617-22	Upper	8-3/4"	'23-'24 61" + '22-'24 74"	n.a.
R2615-25	Lower	19"	'25-'29 61" + 74"	n.a.
R2617-25	Upper	9-3/4"	'25-'29 61" + 74"	20.00
C3434-24	Rocker plate stud kit		'12-'15	97.50 ✪
C3431-24	Rocker plate stud kit		'16-'29	95.00 ✪
C3433-14	Front stand stud kit		'25-'29	59.38 ✪
R2645-13	Bushing, rocker stud		'13-'29	12.50 ✪



A.	R2938-14	Set of footboards (without mats)		n.a. ✪
"	R2938-14B	Set of footboards (without mats) black		n.a. ✪
C.	R2941-14	Set footboard mat rivets (28)	'14-'29	6.95 ✪
"	R2941-42M	Set footboard mat rivets (28) shorter		7.95 ✪
D.	2932-14	Nut, footboard support rod	'14-'29	6.00 ✪
E.	2945-14	Rivet, footboard hinge	'14-'29	1.00 ✪
F.	R0130P	Nut, sidebar clamp park	'14-'29	1.63 ✪
"	R0130	Nut, sidebar clamp cad	'14-'29	2.06 ✪
"	R0130NI	Nut, sidebar clamp Nickle	'14-'29	1.80 ✪
	R2948-14	Footboard stud	'14-'22	15.63 ✪
	R2949-14	Footboard stud	'14-'29	15.63 ✪
	R2950-25	Footboard stud	'25-'29	15.63 ✪
	R2951-24P	Footboard stud	'24-'29	12.50 ✪
G.	R2954-14	Hinge bolt park	'14-'29	4.45 ✪
H.	0108	Nut, hinge bolt park	'14-'29	1.50 ✪
"	R0108P	Nut, hinge bolt park	'14-'29	1.13 ✪
I.	R0256P	Lockwasher, bolt park	'14-'29	0.25 ✪
	C9886-12	Kit, hinge bolt park	'14-'29	16.25 ✪
F.	R0130P	Nut, brake lever stud park	'23-'29	1.63 ✪
"	R0130	Nut, brake lever stud cad	'23-'29	2.06 ✪
"	R0130NI	Nut, brake lever stud Nickle	'23-'29	1.80 ✪

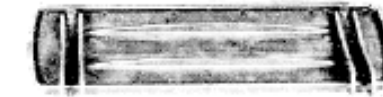

A.

C.

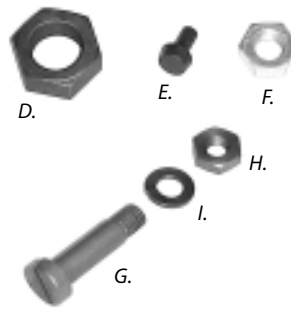

C9886-12

	R3061-24P	Rear stand spring park	'24-'29	2.19 ✪
	R3061-24	Rear stand spring cad	'24-'29	2.40 ✪



Seat Post

J.	3111-12	Seat bar clevis pin park	'12-'28	1.50 ✪
"	3111-12.10pack	10 Pins, cotter pin type		10.00 ✪
K.	3111-29	Seat bar clevis pin park	'29	7.00 ✪
"	R3111-29	Seat bar clevis pin park	'29	2.00
"	R3111-29.10pack	10 Pins, seat bar clevis		15.00
L.	R3112-29	Spring, clevis pin black	'29	4.75
	R3107-25	Pivot bolt cad	'25-'29	18.75 ✪
M.	3117-29	Link, plunger	'29	n.a.
N.	3118-29	Rivet, plunger link	'29	5.00 ✪
O.	3119-13	Bushing, plunger link	'13-'29	6.00 ✪
P.	3143-25	Nut, seat post rod bare	'25-'29	3.50 ✪
R.	3144-25	Nut, rod lock park	'25-'29	5.00 ✪
	R0269P	Lockwasher park	'25-'29	1.50 ✪

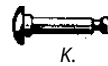

K.

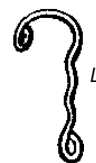

L.



O.



M.



N.



R3107-25



P.



R.

Handlebar Spirals and Parts

	R3310-09	Set handlebar grips	black	n.a.
Spirals fit right side '16-'29, both sides '24-'29				
A.	R3312-16	Spiral, handlebar	bare	'16-'29 n.a.
"	R3312-16C	Spiral, handlebar	chrome	'16-'29 n.a.
"	R3312-16NI	Spiral, handlebar	Nickle	'16-'29 n.a.
B.	R3314-35C	Sleeve for spiral	chrome	'16-'29 n.a.
"	R3314-16NI	Sleeve for spiral	Nickle	'16-'29 n.a.
C.	305-15	Roller pin, plunger		'16-'29 1.50 ☼
D.	R3320-10	Roller, plain		'11-'29 2.50 ☼
E.	R3330-10	Handlebar end nut	Nickle	'10-'21 16.88 ☼
This nut has a hex head, following nut has slotted head (57/64"-24 thread)				
F.	R3330-36	Handlebar end nut	park	'22-'29 8.75 ☼

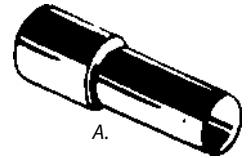
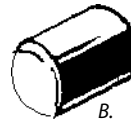

Handlebar Control Cables

G.	R3334-12	Control cable 130 cm	Nickle	'09-'29 n.a.
"	R4143-12	Control cable 215 cm	Nickle	'09-'29 n.a.
"	R3334-32	Control cable 130 cm	pvc	'09-'29 37.50 ☼
"	R3334-39	Control cable 130 cm	cotton	'09-'29 n.a.
H.	R3326-09	Wire, control 150 cm		'09-'29 n.a. ☼
	R3324-09	Nipple, control wire end		'11-'29 1.25 ☼
J.	R3341-28	Adjusting sleeve, coil	park	'28-'29 7.50 ☼
K.	0129	Nut, adjusting sleeve	park	1.50 ☼
L.	R3343-09	Nut, control coil	Nickle	'11-'29 4.38 ☼
M.	R3370-29	Connection, carburetor	park	'29 n.a.

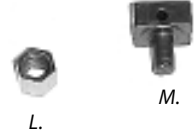
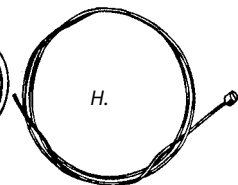
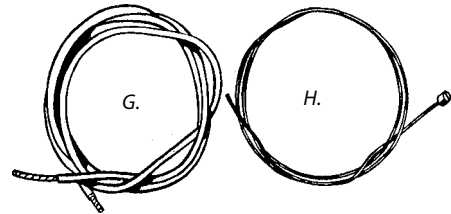

3464-26	Tool box key, electric models	'26-'29	8.00 ☼
----------------	-------------------------------	---------	--------



Gas/Oil Tank

Gas/Oil Tank Parts

B.	R3507-16	Tank cap	chrome	'16-'29	n.a.
----	-----------------	----------	--------	---------	------

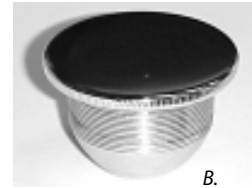

Tank Mounting Screws

C.	R3529-10P	Screw, tank clip	park	'11-'29	6.25 ☼
"	R3529-10	Screw, tank clip	Nickle	'11-'29	6.25 ☼
D.	0108	Nut, tank screw	park		1.50 ☼
"	R0108P	Nut, tank screw	park		1.13 ☼
"	R0108NI	Nut, tank screw	Nickle		1.56 ☼
	R3530-25	Spacer, tank clip screw			6.25 ☼
	C2461-3	Set screws (3)	Nickle	'10-'17	18.13 ☼
	C2462-9	Set screws, nuts (3)	Nickle	'18-'24	21.88 ☼
	C2463-8	Screws, nuts, spacers (2) cad		'25-'29	26.88 ☼



Tank Top Screws

E.	R3532-18P	Screw	7/32"-32	park	4.38 ☼
"	3532-18	Screw	7/32"-32	cad	5.00 ☼
"	R3532-18	Screw	7/32"-32	cad	4.38 ☼
"	R3532-18C	Screw	7/32"-32	chrome	n.a. ☼
"	R3532-18NI	Screw	7/32"-32	Nickle	4.38 ☼
"	3532-18S	Screw, oversize	1/4"-32	park	4.00 ☼
"	R3532-18SP	Screw, oversize	1/4"-28	park	4.38 ☼
"	R3532-18S	Screw, oversize	1/4"-28	cad	4.38 ☼
"	R3532-18SC	Screw, oversize	1/4"-32	chrome	4.38 ☼
"	R3532-18SNI	Screw, oversize	1/4"-28	Nickle	4.38 ☼
F.	R3533-18P	Washer		park	2.00 ☼
"	R3533-18	Washer		cad	2.00 ☼
"	R3533-18C	Washer		chrome	2.81 ☼
"	R3533-18NI	Washer		Nickle	2.00 ☼
"	R3533-18SP	Washer, oversize screw		park	2.00 ☼
"	R3533-18S	Washer, oversize screw		cad	2.00 ☼
"	R3533-18SC	Washer, oversize screw		chrome	n.a. ☼
"	R3533-18SNI	Washer, oversize screw		Nickle	2.00 ☼

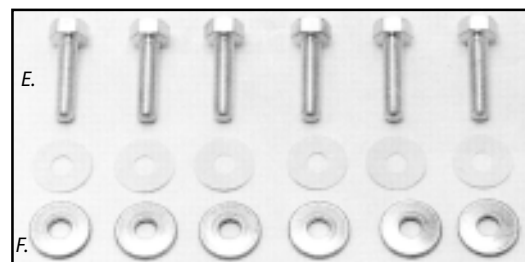

C8822-18

Tank Top Screw Kits

Complete set (6) of top tank screws with washers '18-'29 models.

C8822-18	Set standard	7/32"-32	cad	36.25 ☼
C8821-18	Set standard	7/32"-32	Nickle	36.88 ☼
C2814-18	Set standard	7/32"-32	park	35.31 ☼
C8822-18os	Set oversize	1/4"-28	cad	36.25 ☼
C8821-18os	Set oversize	1/4"-28	Nickle	36.88 ☼
C2817-18	Set oversize	1/4"-28	park	35.31 ☼



tap160-001	Tap, standard screw	7/32"-32	n.a.
M1423T	Tap, oversize screw	1/4"-28	n.a.
tap160-003	Tap, oversize screw	1/4"-32	n.a.

3947-16	Spoke nipple	park	'17-'29	2.00 ☼
----------------	--------------	------	---------	--------



A.	R3571-15	Oil line cad '15-'29 mechanical feed	n.a. ☺
"	R3571-28	Oil line cad '28-'29 JDH models	35.00 ☺
B.	R3572-15	Oil line cad '15-'26 hand pump	n.a. ☺
C.	R3572-27	Oil line cad '27-'29 hand pump	n.a. ☺
D.	R3606-16	Petrol line '16-'29	n.a. ☺
E.	R0140	Nut, valve end & 3572-15 cad	3.75 ☺
F.	R3615-15	Nipple, valve end & 3572-15 cad	5.50 ☺
G.	R3612-09	Nut, carburetor end cad	n.a. ☺
H.	R3617-15	Nipple, carburetor end cad	5.50 ☺
I.	R3577-15P	Nipple, large flare park	5.00 ☺
"	R3577-15	Nipple, large flare cad	5.00 ☺
"	R3577-15C	Nipple, large flare chrome	6.25 ☺
J.	R3581-15	Nut, large flare cad	7.00 ☺
"	R3581-15E	Nut, large flare - early style cad	7.50 ☺
K.	R3583-15	Cap, oil line nipple	2.19 ☺
(use when lines are disconnected to prevent leakage or contamination)			
L.	R3585-15	Tee, petrol line (for repairs) cad	n.a. ☺

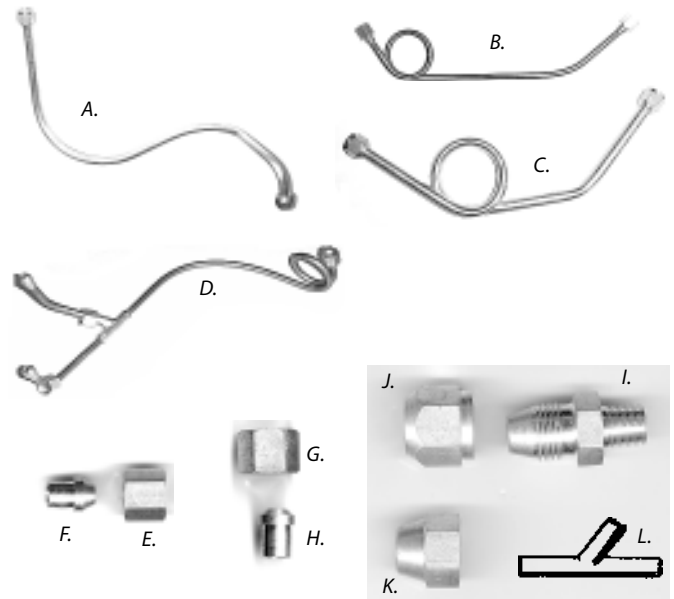

M1902T	tap	1/8-27NPT	n.a.
For rethreading threads for oil line nipple 3577-15 and for petrol valves 3601-16 in tank.			



Fender parts

O.	R0308	Rivet	3/16" x 9/16" round head	0.35 ☺
(to rivet braces to clips)				
P.	0314	Rivet	3/16" x 3/8" truss head	1.00 ☺
(to rivet fenders to braces)				
R.	R3743-23	Bolt with nut	park '23-'29	7.50 ☺
(special carriage bolt for rear fender end)				
	R0117P	Nut only	park '23-'29	1.19 ☺
	R0214P	Washer	park '23-'29	0.50 ☺
	R0259P	Lockwasher	park '23-'29	0.25 ☺
	C2460-2	Bolt kit (2)	park '23-'29	15.00 ☺

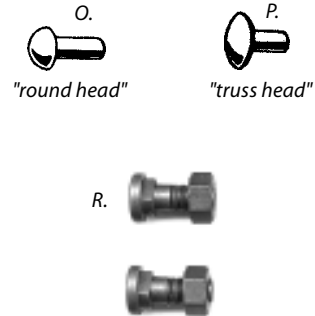

Mudflaps

S.	R3757-26	Mudflap rubber	black	n.a. ☺
Reinforced rubber as original. Includes parkerized hardware.				
T.	R033P	Screw, mudflap	park	0.63 ☺
"	R033	Screw, mudflap	cad	0.69 ☺
"	R033C	Screw, mudflap	chrome	0.85 ☺
U.	R0205P	Washer	park	0.38 ☺
V.	R0254P	Lockwasher	park	0.25 ☺
"	R0254	Lockwasher	zinc	0.20 ☺
"	R0254C	Lockwasher	chrome	0.38 ☺
W.	R0104P	Nut	park	0.50 ☺
"	R0104Z	Nut	zinc	0.40 ☺
"	R0104C	Nut	chrome	0.75 ☺

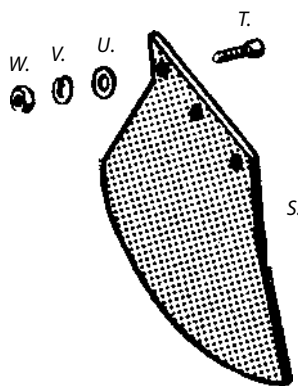

Brakes

Rear Brake

A.	R4065-16	Rear brake rod	park	16-24	n.a. ✖
"	R4065-25	Rear brake rod	park	25-29	n.a. ✖
B.	R0117P	Nut, brake rod	park	16-29	1.19 ✖
"	R0117M	Nut, brake rod	cad	16-29	1.25 ✖
C.	R4068-14	Brake rod end	cad	15-22	21.88 ✖
	C3302-3	Clevis pin with washer (4069-15)	park		7.13 ✖

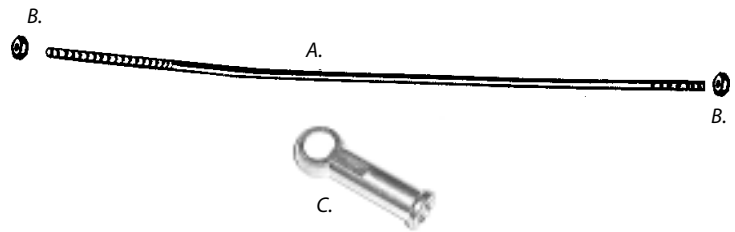

Front wheel

	R3929-16	Cone locknut	Nickle	16-20	18.75 ✖
	R3929-21	Cone locknut	Nickle	21-26	17.50 ✖
	C3213-4	Pair lockwashers/rings			25.00 ✖

Front Brake

D.	R4125-28A	Spring, front brake		28-29	3.00
E.	4131-28	Bushing, brake shackle		28-29	7.00 ✖
	4140-29	Extension nipple	park	29	4.00 ✖



Front Brake Cables

G.	R3334-12	Outer cable, Nickle		130 cm	n.a.
"	R4143-12	Outer cable, Nickle		215 cm	n.a.
"	R4143-30	Outer cable, plastic covered		130 cm	37.00 ✖ (with ferrules)
"	R4143-39	Outer cable, cotton braided		130 cm	n.a.
H.	4145-28	Wire, control (inner cable)		150 cm	n.a.
"	R4145-28	Wire, control (inner cable)		160 cm	7.50 ✖

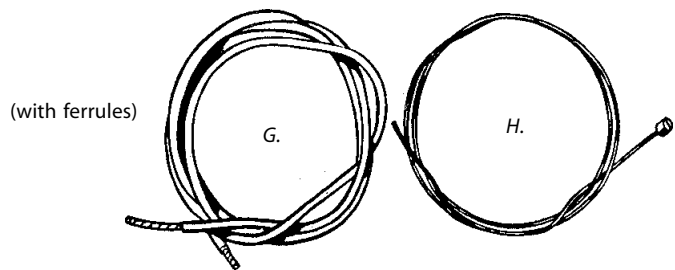

Brake Lever Parts

J.	4154-28	Screw, clamp	park	28-29	3.00 ✖
K.	4156-28	Screw, hand lever	park	28-29	10.00 ✖
L.	4157-28	Spring washer, screw		28-29	4.00 ✖
M.	4160-28	Clamp, handlebar	black	28-29	19.00 ✖
"	R4160-28	Clamp, handlebar	park	28-29	13.75 ✖ (with screw and nut)
N.	053	Screw	park		3.00 ✖
"	R053P	Screw	park		1.56 ✖
"	R053C	Screw	chrome		1.80 ✖
"	R053NI	Screw	Nickle		n.a. ✖
O.	R0256P	Lockwasher	park		0.25 ✖
"	R0256	Lockwasher	zinc		0.25 ✖
"	R0256C	Lockwasher	chrome		0.38 ✖
P.	0108	Nut	park		1.50 ✖
"	R0108P	Nut	park		1.13 ✖
"	R0108M	Nut	cad		1.19 ✖
"	R0108C	Nut	chrome		0.88 ✖
"	R0108NI	Nut	Nickle		1.56 ✖

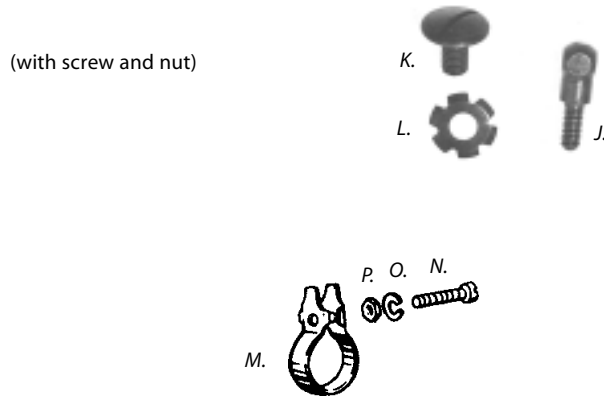

Cable Connecting Parts

R.	R4165-28P	Adjusting screw	park	28-29	10.00 ✖
"	R4165-28	Adjusting screw	cad	28-29	15.00 ✖
"	R4165-28C	Adjusting screw	chrome	28-29	15.63 ✖
S.	R4166-28P	Nut, adjusting screw	park	28-29	1.75 ✖
"	R4166-28	Nut, adjusting screw	cad	28-29	1.88 ✖
"	R4166-28C	Nut, adjusting screw	chrome	28-29	2.50 ✖
T.	4170-28	Connection & nut	park	28-29	14.00 ✖
"	4170-28.2pack	Genuine bag with two connections			30.00 ✖
U.	4171-29	Nut only	park	29	3.00 ✖
V.	4069-26	Pin		28-29	2.00 ✖
W.	0207	Washer	park	28-29	1.00 ✖
X.	R0290P	Cotter pin	park	28-29	0.19
"	R0290	Cotter pin	zinc	28-29	0.15

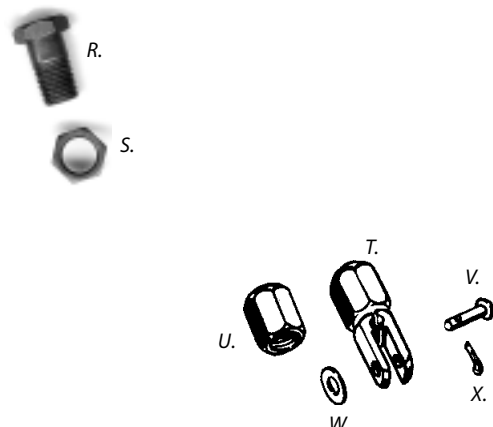

Battery Box Parts

A.	R4409-24P	Wing nut	1/4"-20	park	'24-'25	0.60
"	R4409-24cad	Wing nut	1/4"-20	cad	'24-'25	1.50 ☉
"	R4409-24	Wing nut	1/4"-20	zinc	'24-'25	0.40
"	R4409-24C	Wing nut	1/4"-20	chrome	'24-'25	2.50 ☉
"	R4409-26P	Wing nut	5/16"-18	park	'26-'29	1.50 ☉
"	R4409-26	Wing nut	5/16"-18	cad	'26-'29	1.50 ☉
"	R4409-26C	Wing nut	5/16"-18	chrome	'26-'29	2.50 ☉
B.	4411-24	Bolt, cover clamp			'24-'25	6.00 ☉
C.	R4413-24	Pin, cover clamp bolt			'24-'25	n.a. ☉
D.	4433-23	Screw, terminal	cad	fits	'23-'29	n.a. ☉
E.	4433-23A	Felt, battery terminal		fits	'23-'29	1.00 ☉
F.	4434-23	Nut, terminal screw	cad	fits	'23-'29	1.70 ☉
	R4435-23	Set screws and nuts	cad	fits	'23-'29	17.50 ☉
G.	R4427-15	Mat, battery box			'15-'25	3.50 ☉

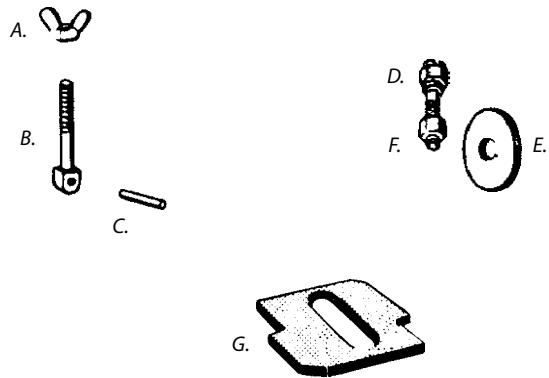

Wiring Kit

H.	R4735-18	Complete wiring kit	'16-'28 electric models	95.00 ☉
"	R4735-29	Complete wiring kit	'29 electric models	129.50 ☉



Wire

fabric as used on '69 and earlier models

R4712-15A	black / white tracer	1 meter	2.00 ☉
R4712-15B	green / white tracer	1 meter	2.00 ☉
R4712-15C	yellow / black tracer	1 meter	2.00 ☉
R4712-15D	red / white tracer	1 meter	2.00 ☉
R4712-15E	green	1 meter	2.00 ☉
R4712-15F	red	1 meter	2.00 ☉
R4712-15G	black / red tracer	1 meter	2.00 ☉
R4712-15H	gray / black tracer	1 meter	2.00 ☉
R4712-15K	red / black tracer	1 meter	2.00 ☉
R4712-15M	blue / white tracer	1 meter	2.00 ☉
R4712-15P	red / yellow tracer	1 meter	2.00 ☉
R4712-15R	black	1 meter	2.00 ☉
R4712-15S	white / blue tracer	1 meter	2.00 ☉
R4712-15T	light blue / black tracer	1 meter	2.00 ☉
R4712-15U	yellow	1 meter	2.00 ☉



Wire Loom

fabric as used on '69 and earlier models

R4711-45A	I.D. 3/16"	4,75mm	1 meter	3.50 ☉
R4711-45B	I.D. 1/4"	6,35mm	1 meter	3.50 ☉
R4711-45C	I.D. 5/16"	7,93mm	1 meter	3.50 ☉
R4711-45D	I.D. 3/8"	9,52mm	1 meter	4.00 ☉
R4711-45E	I.D. 1/2"	12,70mm	1 meter	n.a.



Terminals

"Early" style terminals:

K.	R4715-18	Terminal, round solder type	'18-'37	n.a. ☉
L.	1614-18	Terminal and eyelet	'18-'47	3.00 ☉

"Modern" style terminals:

N.	R1520-40	Flag terminal	14-16 gauge, #10 eye	1.00 ☉
	R1520-43	Flag terminal	14-16 gauge, #12 eye	0.50 ☉
O.	R1520-41	Ring terminal	14-16 gauge, # 6 eye	0.25 ☉
P.	R1520-42	Ring terminal	14-16 gauge, #10 eye	0.25 ☉
R.	R4521-26	Key, switch	cad '26-'29	6.50 ☉
S.	4724-15cad	Small tubing clamp	cad '15-'29	9.00 ☉
"	R4724-15	Small tubing clamp	park '15-'29	5.00 ☉
	R4726-24	Wire clamp, large	park '24-'29	17.00 ☉

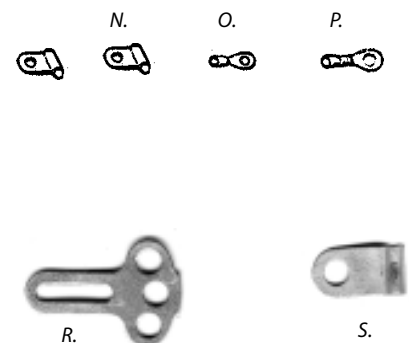

Switches / Bearings

Horn Switch

B.	4762-26	Button		5.00	✳
C.	4764-26	Spring		2.00	✳
D.	4766-26	Insulation		5.00	✳
E.	4776-26	Washer, horn spring		8.00	✳
G.	R018	Screw	cad	0.63	✳
"	R018C	Screw	chrome	0.75	✳

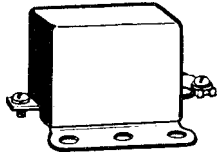
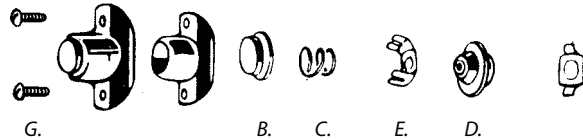

R4785-26	Relay, without cover		'26-'37	47.00
R4786-26DR	Cover	black	'26-'37	23.50
R4786-26DRC	Cover	chrome	'26-'37	25.00

Taillight lenses

R5054-20	Red lens	glass	'20-'33 models	n.a.	✳
R5065-25	White lens	glass	'25-'38 models	37.00	✳



Roller Bearing Roller Guide

-Forked end connecting rod		(24)	'15-'29	
-Left crankcase		(24)	'15-'29	
R304-15	Roller, standard		0.2498" x .360"	n.a.
R304-15D	Roller, oversize		+0.0002"	0.60
R304-15F	Roller, oversize		+0.0004"	0.60
304-15H	Roller, oversize		+0.0006"	1.00
R304-15H	Roller, oversize		+0.0006"	0.60
304-15KA	Roller, oversize		+0.0008"	1.00
R304-15KA	Roller, oversize		+0.0008"	0.60
R304-15MA	Roller, oversize		+0.0010"	n.a.

-Single end connecting rod		(12)	'15-'29	
-Clutch sprocket		(12)	'21-'29	
R305-15	Roller, standard		0.2498" x .726"	1.00
R305-15D	Roller, oversize		+0.0002"	0.60
R305-15F	Roller, oversize		+0.0004"	0.60
R305-15H	Roller, oversize		+0.0006"	0.60
R305-15KA	Roller, oversize		+0.0008"	0.60
R305-15MA	Roller, oversize		+0.0010"	0.60
R305-15MA2	Roller, oversize		+0.0020"	0.60

-Countershaft gear, standard transmission		(24)	'17-'29	
-Main drive gear		(20)	'17-'24	
R2289-17	Roller, standard		0.2498" x .270"	n.a.
R2289-17D	Roller, oversize		+0.0002"	0.50
R2289-17F	Roller, oversize		+0.0004"	0.50
R2289-17H	Roller, oversize		+0.0006"	0.50
R2289-17KA	Roller, oversize		+0.0008"	0.50
R2289-17MA	Roller, oversize		+0.0010"	0.50



100-packs available through website

-Rear wheel hub		(32)	'23-'29	
-Main drive gear		(20)	'25-'29	
R2289-25	Roller, standard		0.2498" x .490"	0.50
R9219	Roller, oversize		+0.0001"	0.50
R2289-25D	Roller, oversize		+0.0002"	0.50
R9218	Roller, oversize		+0.0003"	0.50
R2289-25F	Roller, oversize		+0.0004"	0.50
R9217	Roller, oversize		+0.0005"	0.50
R2289-25H	Roller, oversize		+0.0006"	0.50
R2289-25KA	Roller, oversize		+0.0008"	0.50
R2289-25MA	Roller, oversize		+0.0010"	0.50
R2289-25MA2	Roller, oversize		+0.0020"	0.50

Feeler Gauges



MFG002 25- Blade .0015" - .035" n.a.

U.S. Pitch Gauge

M3118PG Measures number of threads per inch n.a.
Essential tool for determining all UNF/UNC and special thread sizes.



Thread Files

To restore externally damaged threads.

MTR1 Contains most popular sizes n.a.
(11, 12, 13, 14, 16, 18, 20, 24 threads per inch)

MTR2 Contains less used sizes n.a.
(9, 10, 12, 16, 20, 27, 28, 32 threads per inch)



R1080 Solid brass hammer, 48 oz. 1-1/4" head 120.00 ☺



R1081 Solid brass punch set, 4-piece 139.50 ☺
Includes 3/8", 1/2", 5/8", 3/4" punch, use 3/8" punch for setting oil pump check valve ball.



Grease Guns

- Alemite connections are used with "Alemite" nipples ('24-'37 models).
- Hydraulic connections are for use with '38-up "Zerk" grease nipples.

GG1 Grease gun, with hydraulic connection n.a.
GG3 Grease gun, with Alemite connection n.a.

Grease gun for Alemite nipples uses flexible hose.

GG4 High pressure hose only 9.50
GG6 Alemite nipple head 47.50



GG6

C2962-6 Alemite grease nipples (6) brass '24-'37 22.50
C8770-6 Alemite grease nipples (6) Nickle '24-'37 22.50

Heli-Coil® / Taps & Dies



Heli-Coil® has the most effective and universally accepted method of thread repair. Heli-Coil® inserts quickly and permanently restore stripped, worn or damaged threads to their original size and condition.

Heli-Coil® Thread Repair Kits

Individual kits come complete with a quantity of Heli-Coil® stainless steel inserts, a tap and an installation tool, order correct size drill seperately. All kits come with step-by-step instructions.



Heli-Coil® Kits, UNF-UNC

Kit	Thread	Inserts	Length	Use drill	
H5521-2	8-32	12	.246"	11/64"	56.00
H5521-3	10-24	12	.285"	13/64"	56.00
H5528-3	10-32	12	.285"	13/64"	65.00
H5521-1	12-24	12	.324"	15/64"	57.00
H5521-4	1/4"-20	12	.375"	17/64"	43.00
H5528-4	1/4"-28	12	.375"	17/64"	65.00
H5521-5	5/16"-18	12	.469"	21/64"	41.00
H5528-5	5/16"-24	12	.469"	21/64"	65.00
H5521-6	3/8"-16	12	.562"	25/64"	44.00
H5528-6	3/8"-24	12	.562"	25/64"	65.00
H5521-7	7/16"-14	6	.656"	29/64"	44.00
H5528-7	7/16"-20	6	.656"	26/64"	65.00

Inserts only, UNF-UNC

Set	Thread	Inserts	Length	
HR1185-2	8-32	12	.246"	20.00
HR1185-3	10-24	12	.285"	21.00
HR1191-3	10-32	12	.285"	21.00
HR1185-1	12-24	12	.324"	21.00
HR1185-4	1/4"-20	12	.375"	21.00
HR1191-4	1/4"-28	12	.375"	21.00
HR1185-5	5/16"-18	12	.469"	21.00
HR1191-5	5/16"-24	12	.469"	21.00
HR1185-6	3/8"-16	12	.562"	26.00
HR1191-6	3/8"-24	12	.562"	26.00
HR1185-7	7/16"-14	6	.656"	20.00
HR1191-7	7/16"-20	6	.656"	20.00

Heli-Coil® Kits, Special

Kit	Thread	Inserts	Length	Use drill	
H5540-4	1/4"-24	12	.500"	17/64"	125.00
Gear cover screws, tappet guide screws, oil pump, etc.					
H5540-6	3/8"-20	6	.375"	25/64"	83.00
Brake drum wheel bolts 1936-1972.					
H5540-7	7/16"-16	6	.656"	29/64"	n.a.
Headbolts 1930-1973 Flatheads, 1936-1947 Knucklehead.					
H5521-8-2	1/2"-13	6	.375"	17/32"	75.00
Early Sportster engine and transmission.					
H5528-8-2	1/2"-20	6	.375"	33/64"	77.00
Primary plug, Sportster transmission.					
H5528-10-2	5/8"-18	6	.325"	41/64"	n.a.
Timing hole plug '31-up.					
H5523-14	M14-1.25	30	3/8"		165.00
Spark plugs 1948-1974 Panhead, Shovelhead, Sportster.					
H5523-18	M18-1.50	24	.500"		n.a.
Spark plugs 1930-1973 Flatheads, 1936-1947 Knucklehead.					
H5407-2	1/8"-27 NPT				170.00

Inserts only, Special

Set	Thread	Inserts	Length	
HR389-4	1/4"-24	12	.500"	25.00
HR389-6	3/8"-20	6	.375"	16.00
HR389-7-2	7/16"-16	6	.656"	24.00
HR1185-8-2	1/2"-13	6	.375"	21.00
HR1191-8-2	1/2"-20	6	.375"	24.00
HR1191-10-2	5/8"-18	6	.325"	38.00
HR512	M14-1.25	6	3/8"	17.50
HR514-6	M18-1.50	6	.500"	24.00
HR327-2	1/8"-27 NPT	12		30.00

Taps and Dies, Special Sizes

tap160-001	7/32"-32	tap	n.a.	Tank top filler strip 750cc '37-'73, tank mounting, all models '18-'35.
M1421T	1/4"-24	tap	7.00	This thread size has many applications on the older Harley's, including gear cover screws, tappet guide screws, oil pump nuts, etc.
die160-005	1/4"-24	die	n.a.	Linkert carburetor float lever pin (1196-11 and 1197-16) and bowl drain screw (1269-39), also oversize tank top screw.
tap160-003	1/4"-32	tap	n.a.	
tap160-002	1/4"-40	tap	n.a.	Linkert carburetor low and high speed needle. (in housing and in lever 1292-27)
tap160-011	9/32"-32	tap	n.a.	Bendix carburetors.
tap160-809	5/16"-32	tap	n.a.	Grease nipples, 1924 and later.
tap160-807	3/8"-20	tap	10.00	Wheel bolts 1936-1972.
die160-007	3/8"-20	die	n.a.	
tap160-416	7/16"-16	tap	n.a.	Head bolts, all Flatheads with headbolts 1930-1973, all Knuckleheads 1936-1947.
die160-006	7/16"-16	die	n.a.	
tap160-012	7/16"-24	tap	n.a.	Oversize cylinder head studs 750cc.
tap160-010	7/16"-28	tap	n.a.	750cc models '41-'73 clutch lever.
C9407-1	11/16"-16	tap	45.00	Oversize timing hole plug
tap160-004	3/4"-18	tap	n.a.	1940-1965 petrol valve nipple in tank.
die160-008	3/4"-20	die	n.a.	Linkert carburetor bowl lock nut (1268-29)
tap160-904	13/16"-24	tap	n.a.	Handlebar end screw 750cc models '31-'39, all models '31-'35.
tap160-905	7/8"-24	tap	n.a.	Handlebar end screw (3330-36), 1936-1948.
die160-009	7/8"-24	die	n.a.	Fork stem 750cc models.



Taps, high carbon steel, UNF/UNC

M1111T	4-36	4.50	M1427T	5/16"-18	5.75
M1112T	4-40	4.50	M1429T	5/16"-24	5.75
M1118T	6-32	4.50	M1434T	3/8"-16	6.00
M1124T	8-32	4.50	M1436T	3/8"-24	6.00
M1128T	10-24	4.50	M1439T	7/16"-14	7.00
M1131T	10-32	4.50	M1440T	7/16"-20	7.00
M1132T	12-24	4.50	M1444T	1/2"-13	8.00
M1135T	14-20	4.50	M1445T	1/2"-20	8.00
M1412T	3/16"-24	4.50	M1448T	9/16"-12	11.00
M1420T	1/4"-20	4.50	M1449T	9/16"-18	11.00
M1423T	1/4"-28	4.50			

Please Check Website For Availability



Dies, high carbon steel, UNF/UNC

M6112DI	4-40	8.00	M6527DI	5/16"-18	8.00
M6118DI	6-32	8.00	M6529DI	5/16"-24	8.00
M6124DI	8-32	8.00	M6534DI	3/8"-16	8.00
M6128DI	10-24	8.00	M6536DI	3/8"-24	8.00
M6131DI	10-32	8.00	M6539DI	7/16"-14	8.00
M6132DI	12-24	8.00	M6540DI	7/16"-20	8.00
M6520DI	1/4"-20	8.00	M6544DI	1/2"-13	8.00
M6523DI	1/4"-28	8.00	M6545DI	1/2"-20	8.00



Drills

General purpose drills made of fine quality high speed steel.
Hardened and tempered with extreme accuracy to retain sharpness and long life.



Fractional Sizes

M6104D	1/16"	2.00	M6112D	3/16"	3.50	M6120D	5/16"	7.00	M6128D	7/16"	12.00
M6105D	5/64"	2.00	M6113D	13/64"	3.50	M6121D	21/64"	9.00	M6129D	29/64"	15.00
M6106D	3/32"	2.00	M6114D	7/32"	3.50	M6122D	11/32"	9.00	M6130D	15/32"	15.00
M6107D	7/64"	2.00	M6115D	15/64"	5.00	M6123D	23/64"	8.75	M6131D	31/64"	17.00
M6108D	1/8"	3.00	M6116D	1/4"	5.00	M6124D	3/8"	9.50	M6132D	1/2"	17.00
M6109D	9/64"	3.00	M6117D	17/64"	5.00	M6125D	25/64"	9.50	M9134D	17/32"	32.50
M6110D	5/32"	3.00	M6118D	9/32"	5.00	M6126D	13/32"	9.50		(1/2" shank)	
M6111D	11/64"	3.00	M6119D	19/64"	7.00	M6127D	27/64"	12.00			

Letter Sizes

M4101D	A	.234"	4.00	M4108D	H	.266	5.00	M4115D	O	.316	6.75	M4122D	V	.377	9.75
M4102D	B	.238	4.00	M4109D	I	.272	5.00	M4116D	P	.323	8.00	M4123D	W	.386	9.75
M4103D	C	.242	4.00	M4110D	J	.277	5.75	M4117D	Q	.332	8.00	M4124D	X	.397	11.50
M4104D	D	.246	4.00	M4111D	K	.281	5.75	M4118D	R	.339	8.00	M4125D	Y	.404	12.50
M4105D	E	.250	4.00	M4112D	L	.290	5.75	M4119D	S	.348	9.75	M4126D	Z	.413	14.50
M4106D	F	.257	5.00	M4113D	M	.295	6.75	M4120D	T	.358	9.75				
M4107D	G	.261	5.00	M4114D	N	.302	6.75	M4121D	U	.368	9.75				

Number Sizes

M8101D	1	.228	4.00	M8121D	21	.159	2.50	M8141D	41	.096	2.00	M8161D	61	.039	2.30
M8102D	2	.221	4.00	M8122D	22	.157	2.50	M8142D	42	.093	2.00	M8162D	62	.038	2.30
M8103D	3	.213	4.00	M8123D	23	.154	2.50	M8143D	43	.089	2.00	M8163D	63	.037	2.30
M8104D	4	.209	4.00	M8124D	24	.152	2.50	M8144D	44	.086	2.00	M8164D	64	.036	2.30
M8105D	5	.205	4.00	M8125D	25	.149	2.50	M8145D	45	.082	2.00	M8165D	65	.035	2.30
M8106D	6	.204	4.00	M8126D	26	.147	2.50	M8146D	46	.081	2.00	M8166D	66	.033	2.30
M8107D	7	.201	4.00	M8127D	27	.144	2.50	M8147D	47	.078	2.00	M8167D	67	.032	2.30
M8108D	8	.199	4.00	M8128D	28	.140	2.50	M8148D	48	.076	2.00	M8168D	68	.031	2.30
M8109D	9	.196	4.00	M8129D	29	.136	2.50	M8149D	49	.073	2.00	M8169D	69	.0292	2.30
M8110D	10	.193	4.00	M8130D	30	.128	2.50	M8150D	50	.070	2.00	M8170D	70	.028	2.30
M8111D	11	.191	4.00	M8131D	31	.120	2.00	M8151D	51	.067	2.00	M8171D	71	.026	2.30
M8112D	12	.189	3.50	M8132D	32	.116	2.00	M8152D	52	.063	2.00	M8172D	72	.025	2.30
M8113D	13	.185	3.50	M8133D	33	.113	2.00	M8153D	53	.059	2.00	M8173D	73	.025	2.30
M8114D	14	.182	3.50	M8134D	34	.111	2.00	M8154D	54	.055	2.00	M8174D	74	.0225	2.30
M8115D	15	.180	3.50	M8135D	35	.110	2.00	M8155D	55	.052	2.00	M8175D	75	.021	2.70
M8116D	16	.177	3.50	M8136D	36	.106	2.00	M8156D	56	.046	2.30	M8176D	76	.020	2.70
M8117D	17	.173	3.50	M8137D	37	.104	2.00	M8157D	57	.043	2.30	M8177D	77	.018	2.70
M8118D	18	.169	2.50	M8138D	38	.101	2.00	M8158D	58	.042	2.30	M8178D	78	.016	2.70
M8119D	19	.166	2.50	M8139D	39	.099	2.00	M8159D	59	.041	2.30	M8179D	79	.0145	2.70
M8120D	20	.161	2.50	M8140D	40	.098	2.00	M8160D	60	.040	2.30	M8180D	80	.0135	2.70

Screws, Bolts, Nuts

Round Head Screws

Listed by size.



R016P	6-32 x 3/8"	park	0.63
R016Z	6-32 x 3/8"	zinc	0.30
R013Z	6-32 x 7/8"	zinc	0.30
R018P	8-32 x 1/4"	park	0.56
R018	8-32 x 1/4"	cad	0.63
R018C	8-32 x 1/4"	chrome	0.75
4940-35	8-32 x 1/4"	zinc	1.50
R019P	8-32 x 5/16"	park	0.56
R019	8-32 x 5/16"	cad	0.63
R027P	8-32 x 5/8"	park	0.63
R027	8-32 x 5/8"	cad	0.69
R026Z	8-32 x 1"	zinc	0.50
R030	10-24 x 3/8"	cad	0.69
R030P	10-24 x 3/8"	park	0.63
R030Z	10-24 x 3/8"	zinc	0.30
R030C	10-24 x 3/8"	chrome	0.75
R031P	10-24 x 1/2"	park	0.63
R031Z	10-24 x 1/2"	zinc	0.30
R031C	10-24 x 1/2"	chrome	0.60
R034	10-32 x 1/4"	cad	0.50
R034P	10-32 x 1/4"	park	0.63
R034Z	10-32 x 1/4"	zinc	0.30
R034C	10-32 x 1/4"	chrome	0.60
4941-35	10-32 x 1/4"	zinc	1.00
R041P	12-24 x 3/8"	park	0.75
R041Z	12-24 x 3/8"	zinc	0.30
R043P	12-24 x 1/2"	park	0.60
R043Z	12-24 x 1/2"	zinc	0.30
R4918-35P	12-24 x 3/4"	park	1.00
R4918-35	12-24 x 3/4"	cad	1.06
R4918-35C	12-24 x 3/4"	chrome	1.50
050	1/4-24 x 7/16"	park	2.00
R050P	1/4-24 x 7/16"	park	1.38
R050	1/4-24 x 7/16"	cad	1.44
R050C	1/4-24 x 7/16"	chrome	1.63
R050NI	1/4-24 x 7/16"	Nickle	n.a.
R051P	1/4-24 x 1/2"	park	1.44
R051	1/4-24 x 1/2"	cad	1.50
R051C	1/4-24 x 1/2"	chrome	2.63
052	1/4-24 x 5/8"	park	2.00
R052P	1/4-24 x 5/8"	park	1.50
R052	1/4-24 x 5/8"	cad	1.56
R052C	1/4-24 x 5/8"	chrome	2.19
053	1/4-24 x 3/4"	park	3.00
R053	1/4-24 x 3/4"	cad	1.63
R053P	1/4-24 x 3/4"	park	1.56
053Z	1/4-24 x 3/4"	zinc	n.a.
R053C	1/4-24 x 3/4"	chrome	1.80
R053NI	1/4-24 x 3/4"	Nickle	n.a.

Fillister Head Screws

Listed by size.



R010P	6-32 x 1/4"	zinc	0.44
R010Z	6-32 x 1/4"	zinc	0.30
R011P	6-32 x 3/8"	park	0.56
R011Z	6-32 x 3/8"	zinc	n.a.
R011C	6-32 x 3/8"	chrome	0.60
R020	8-32 x 1/4"	cad	0.63
R020P	8-32 x 1/4"	park	0.56
R020Z	8-32 x 1/4"	zinc	0.30
R020C	8-32 x 1/4"	chrome	0.60
R021P	8-32 x 3/8"	park	0.63
R021	8-32 x 3/8"	cad	0.63
R021Z	8-32 x 3/8"	zinc	0.30
R021C	8-32 x 3/8"	chrome	0.60
R021NI	8-32 x 3/8"	Nickle	0.88
4918-42	8-32 x 3/8"	green	0.40
R024P	8-32 x 3/4"	park	0.63
R024Z	8-32 x 3/4"	zinc	n.a.
R024C	8-32 x 3/4"	chrome	n.a.
R026P	8-32 x 1"	park	0.75
R030AP	10-24 x 3/8"	park	0.75
R030A	10-24 x 3/8"	cad	0.75
R030AZ	10-24 x 3/8"	zinc	0.30
R032P	10-24 x 1/2"	park	0.63
R032	10-24 x 1/2"	cad	0.69
R032C	10-24 x 1/2"	chrome	0.81
R033P	10-24 x 5/8"	park	0.63
R033	10-24 x 5/8"	cad	0.69
R033Z	10-24 x 5/8"	zinc	0.30
R033C	10-24 x 5/8"	chrome	0.85
R033LP	10-24 x 3/4"	park	0.75
R033L	10-24 x 3/4"	cad	0.75
R033LC	10-24 x 3/4"	chrome	0.90
R033XL	10-24 x 1"	cad	0.75
R033XLC	10-24 x 1"	chrome	0.90
R035P	10-32 x 3/8"	park	0.63
R035	10-32 x 3/8"	cad	0.69
R035C	10-32 x 3/8"	chrome	0.81
R035NI	10-32 x 3/8"	Nickle	0.65
R036P	10-32 x 1/2"	park	0.63
R036	10-32 x 1/2"	cad	0.69
R036C	10-32 x 1/2"	chrome	0.81
R036NI	10-32 x 1/2"	Nickle	n.a.
R037P	10-32 x 5/8"	park	0.63
R037	10-32 x 5/8"	cad	0.69
R037C	10-32 x 5/8"	chrome	1.13
R037NI	10-32 x 5/8"	Nickle	0.90
R038P	10-32 x 3/4"	park	0.63
R038Z	10-32 x 3/4"	zinc	0.50
R038C	10-32 x 3/4"	chrome	n.a.
R038AP	10-32 x 7/8"	park	0.63
R038A	10-32 x 7/8"	cad	0.50
R1523-26	10-32 x 1-1/4"	zinc	1.50
R042P	12-24 x 1/2"	park	0.63
R042	12-24 x 1/2"	cad	0.69
R042C	12-24 x 1/2"	chrome	0.88
R042NI	12-24 x 1/2"	Nickle	n.a.
4967-42MD	12-24 x 1/2"	special	1.50
R044Z	12-24 x 7/8"	zinc	0.50
R044C	12-24 x 7/8"	chrome	n.a.

Oval Countersunk Head Screws

Listed by size.



2265W	12-24 x 3/8"	zinc	1.00
R048C	12-24 x 3/8"	chrome	0.80
R048AP	12-24 x 1/2"	park	0.94
R048A	12-24 x 1/2"	cad	1.00
R048AC	12-24 x 1/2"	chrome	1.25
R045	12-24 x 21/32"	cad	1.38
047	12-24 x 13/16"	park	2.00
R047P	12-24 x 13/16"	park	1.38
047cad	12-24 x 13/16"	cad	2.00
R047	12-24 x 13/16"	cad	1.44
R047C	12-24 x 13/16"	chrome	1.69
R1409-41MP	12-24 x 2-1/4"	park	4.06
R1409-41M	12-24 x 2-1/4"	cad	4.06
R057P	1/4-24 x 13/16"	park	1.56
R057	1/4-24 x 13/16"	cad	1.56
R057C	1/4-24 x 13/16"	chrome	2.19
R057NI	1/4-24 x 13/16"	Nickle	1.75
R2268-36P	1/4-24 x 13/16"	park	1.25
R2268-36	1/4-24 x 13/16"	cad	1.44
R2268-36C	1/4-24 x 13/16"	chrome	1.88
056	1/4-24 x 1-1/8"	park	1.95
R056P	1/4-24 x 1-1/8"	park	1.88
R056	1/4-24 x 1-1/8"	cad	1.88
R056C	1/4-24 x 1-1/8"	chrome	2.31
R056NI	1/4-24 x 1-1/8"	Nickle	n.a.
2341HW	1/4-24 x 1-1/8"	zinc	2.00
R1523-32P	1/4-24 x 2"	park	3.75
R1523-32	1/4-24 x 2"	cad	3.75
R1523-32C	1/4-24 x 2"	chrome	5.00
R1523-36P	1/4-24 x 3"	park	4.06
R1523-36	1/4-24 x 3"	cad	4.06
R1523-36C	1/4-24 x 3"	chrome	5.63
058	5/16-18 x 13/16"	bare	3.00
R3805-30AP	5/16-24 x 19/32"	park	5.00
R3805-30A	5/16-24 x 19/32"	cad	5.00
R3749-30P	5/16-24 x 27/32"	park	6.00
R3749-30	5/16-24 x 27/32"	cad	6.00
R3749-30C	5/16-24 x 27/32"	chrome	7.00



Hex Head Bolts



Listed by size:

R4518-36	10-32 x 5/16"		cad	2.25
R4518-36C	10-32 x 5/16"		chrome	3.00
R1409-36P	12-24 x 3/8"		park	2.50
R1409-36	12-24 x 3/8"		cad	2.50
R054Z	1/4-20 x 1"	'grade'	zinc	0.40
R054C	1/4-20 x 1"		chrome	1.30
R692-41P	1/4-20 x 1-1/4"		park	1.88
R692-41	1/4-20 x 1-1/4"	'grade'	cad	1.88
R692-41C	1/4-20 x 1-1/4"		chrome	2.50
054A	1/4-24 x 1/2"		zinc	4.00
1123-29	1/4-24 x 5/8"		park	1.50
R1123-29	1/4-24 x 5/8"		cad	3.13
R1123-29C	1/4-24 x 5/8"		chrome	4.06
053E	1/4-24 x 3/4"		park	3.00
R053EP	1/4-24 x 3/4"		park	2.50
7223-34	1/4-24 x 3/4"	'1035 cp'	park	n.a.
R7223-34	1/4-24 x 3/4"		cad	2.50
R7223-34C	1/4-24 x 3/4"		chrome	3.75
R13332-25AP	1/4-24 x 1-5/8"		park	3.13
13332-25Acad	1/4-24 x 1-5/8"	'rockford'	cad	3.20
R13332-25A	1/4-24 x 1-5/8"		cad	3.13
R13332-25AC	1/4-24 x 1-5/8"		chrome	4.06
R1725-30P	1/4-28 x 7/16"		park	1.88
R054WZ	1/4-28 x 5/8"		zinc	0.50
R054WC	1/4-28 x 5/8"		chrome	1.30
R4017P	5/16-18 x 1"	'1038 cp'	park	3.50
443-37P	5/16-18 x 2-3/4"		park	n.a.
443-37	5/16-18 x 2-3/4"	'1035 cp'	cad	3.00
061	5/16-24 x 1/2"	'1035 cp'	park	2.50
R061P	5/16-24 x 1/2"	'1038 cp'	park	1.63
R061Z	5/16-24 x 1/2"	'grade'	zinc	0.35
R061	5/16-24 x 1/2"	'1038 cp'	cad	1.69
R061C	5/16-24 x 1/2"		chrome	1.40
060	5/16-24 x 9/16"		park	3.00
R064PS	5/16-24 x 3/4"		park	1.81
R064P	5/16-24 x 3/4"	'1038 cp'	park	1.81
R064Z	5/16-24 x 3/4"	'grade'	zinc	0.60
R064	5/16-24 x 3/4"	'1038 cp'	cad	1.88
R064C	5/16-24 x 3/4"		chrome	2.13
R064EP	5/16-24 x 7/8"	'1038 cp'	park	2.19
R066PS	5/16-24 x 1"	'1038 cp'	park	2.19
R066P	5/16-24 x 1"	'1038 cp'	park	2.19
R066Z	5/16-24 x 1"	'grade'	zinc	0.75
R066C	5/16-24 x 1"		chrome	1.30
R066AP	5/16-24 x 1-1/8"	'1038 cp'	park	2.31
R066A	5/16-24 x 1-1/8"	'1038 cp'	cad	2.31
R3748-26P	5/16-24 x 1-1/8"	'1038 cp'	park	2.50
R3748-26	5/16-24 x 1-1/8"	'grade'	cad	2.50
R3748-26C	5/16-24 x 1-1/8"		chrome	2.50
R066BP	5/16-24 x 1-3/8"	'1038 cp'	park	2.50
069	5/16-24 x 1-3/8"	dome head	park	1.50
R068PS	5/16-24 x 1-13/16"		park	2.63
R068P	5/16-24 x 1-13/16"	'1038 cp'	park	2.63
R068	5/16-24 x 1-13/16"	'1038 cp'	cad	2.81
R068C	5/16-24 x 1-13/16"		chrome	1.50
R3529-37PS	5/16-24 x 2-1/4"		park	3.13
R3529-37P	5/16-24 x 2-1/4"	'1038 cp'	park	3.13
R3529-37	5/16-24 x 2-1/4"	'1038 cp'	cad	3.25
R3529-37C	5/16-24 x 2-1/4"		chrome	3.75

About hex head markings:

'41 and earlier bolts were usually made by Harley and were not marked (plain head). War-time production saw the arrival of other suppliers, these could be marked "1035 cp" or "1038 cp".



Hex Head Bolts (continued)

R3529-36PS	5/16-24 x 2-5/8"		park	3.44
R3529-36P	5/16-24 x 2-5/8"	'1038 cp'	park	3.44
R3529-36C	5/16-24 x 2-5/8"		chrome	3.75
R070P	3/8-16 x 3/4"	'1035 cp'	park	3.38
R070Z	3/8-16 x 3/4"	'grade'	zinc	0.50
R070	3/8-16 x 3/4"	'1035 cp'	cad	3.44
R070C	3/8-16 x 3/4"		chrome	1.40
R072Z	3/8-16 x 7/8"	'grade'	zinc	0.50
R2263-36BP	3/8-16 x 1"		park	2.19
R2263-36B	3/8-16 x 1"	'grade'	cad	1.85
R2263-36BC	3/8-16 x 1"		chrome	2.25
071	3/8-16 x 1-3/16"		park	4.00
R071P	3/8-16 x 1-3/16"		park	3.75
R071	3/8-16 x 1-3/16"		cad	3.75
R071C	3/8-16 x 1-3/16"		chrome	4.69
073	3/8-16 x 1-3/8"		park	5.00
R073P	3/8-16 x 1-3/8"		park	3.75
R073	3/8-16 x 1-3/8"		cad	3.75
R073C	3/8-16 x 1-3/8"		chrome	4.69
R444-30P	3/8-16 x 3-1/4"		park	4.38
R444-30	3/8-16 x 3-1/4"		cad	4.38
R444-30C	3/8-16 x 3-1/4"		chrome	5.31
R074P	3/8-24 x 3/4"		park	2.50
R074Z	3/8-24 x 3/4"	'grade'	zinc	0.50
R074C	3/8-24 x 3/4"		chrome	1.40
R074NI	3/8-24 x 3/4"		Nickle	n.a.
2823-26	3/8-24 x 7/8"		park	7.00
R2823-26P	3/8-24 x 7/8"		park	5.00
R2823-26	3/8-24 x 7/8"		cad	5.00
R2823-26C	3/8-24 x 7/8"		chrome	6.75
4336W	3/8-24 x 1-1/8"	'grade'	zinc	2.50
2100-16	3/8-24 x 1-1/8"	dome head	park	8.00
R2100-16C	3/8-24 x 1-1/8"	dome head	chrome	9.38
R079P	3/8-24 x 1-1/8"		park	4.06
R079	3/8-24 x 1-1/8"		cad	4.19
R079C	3/8-24 x 1-1/8"		chrome	4.81
R078C	3/8-24 x 1-1/4"		chrome	1.50
R075	3/8-24 x 1-3/8"		cad	5.63
R075C	3/8-24 x 1-3/8"		chrome	6.25
R075P	3/8-24 x 1-3/8"		park	5.63
R437-26P	3/8-24 x 1-3/4"	'1035 cp'	park	6.25
R437-26	3/8-24 x 1-3/4"	'1035 cp'	cad	6.25
R437-26C	3/8-24 x 1-3/4"		chrome	7.50
R437-36P	3/8-24 x 2-5/8"		park	6.25
R437-36	3/8-24 x 2-5/8"	'1038 cp'	cad	6.25
R437-36C	3/8-24 x 2-5/8"		chrome	7.50
R438-36P	3/8-24 x 3-5/16"	'1038 cp'	park	7.50
R438-36	3/8-24 x 3-5/16"	'1038 cp'	cad	7.50
R438-36C	3/8-24 x 3-5/16"		chrome	8.75
2807-30	7/16-20 x 1"		park	5.00
2807-3035	7/16-20 x 1"	'1035 cp'	park	8.00
R080P	7/16-20 x 1-1/2"		park	6.25
R080Z	7/16-20 x 1-1/2"	'grade'	zinc	0.70
R080C	7/16-20 x 1-1/2"		chrome	1.70
R6033-30P	7/16-20 x 1-5/16"	'1035 cp'	park	5.13
R6033-30	7/16-20 x 1-5/16"	'1035 cp'	cad	5.13
R6033-30C	7/16-20 x 1-5/16"		chrome	6.88
14-30	7/16-20 x 1-3/4"		park	10.00

Screws, Bolts, Nuts

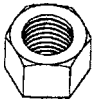

About nuts:

Early 1940's and earlier nuts were mostly manufactured by H-D and were machined from stock. These nuts are clearly different than the later style nuts. We have marked all the nuts on this page with a 'm' to indicate that they are machined.

'machined'
(sharp edges)



not 'machined'
(round edges)

Nuts

Listed by size:

R0101P	6-32 x 7/64" x 5/16"	park	0.50
R0101B	6-32 x 7/64" x 5/16"	brass	0.50
R0101Z	6-32 x 7/64" x 5/16"	zinc	0.40
R0103P	8-32 x 1/8" x 11/32"	park	0.50
R0103	8-32 x 1/8" x 11/32"	cad	0.50
R0103Z	8-32 x 1/8" x 11/32"	zinc	0.40
R0104P	10-24 x 1/8" x 3/8"	park	0.50
R0104	10-24 x 1/8" x 3/8"	cad	0.50
R0104Z	10-24 x 1/8" x 3/8"	zinc	0.40
R0104C	10-24 x 1/8" x 3/8"	chrome	0.75
R0104FP	10-24 x 3/8" flexlock	park	1.06
R0104F	10-24 x 3/8" flexlock	cad	1.06
R0104FNI	10-24 x 3/8" flexlock	Nickle	1.35
4434-23	10-24 x 1/4" x 3/8"	'm' cad	1.70
0105cop	10-32 x 1/8" x 5/16"	brass	0.70
0105copm	10-32 x 1/8" x 5/16"	'm' brass	1.30
0105cad	10-32 x 1/8" x 5/16"	cad	1.00
R0105Z	10-32 x 1/8" x 5/16"	zinc	0.30
R0105C	10-32 x 1/8" x 5/16"	chrome	0.50
R0105AP	10-32 x 1/8" x 3/8"	park	0.50
R0105AZ	10-32 x 1/8" x 3/8"	zinc	0.50
R0105AC	10-32 x 1/8" x 3/8"	chrome	n.a.
R0106P	12-24 x 5/32" x 7/16"	park	0.50
R0106	12-24 x 5/32" x 7/16"	cad	0.50
R0106Z	12-24 x 5/32" x 7/16"	zinc	0.30
R0107C	1/4-20 x 1/4" x 7/16"	chrome	1.13
R0107P	1/4-20 x 1/4" x 1/2"	'm' park	1.13
R0107	1/4-20 x 1/4" x 1/2"	'm' cad	1.19
0108	1/4-24 x 5/32" x 7/16"	'm' park	1.50
R0108P	1/4-24 x 5/32" x 7/16"	'm' park	1.13
R0108M	1/4-24 x 5/32" x 7/16"	'm' cad	1.19
R0108C	1/4-24 x 5/32" x 7/16"	chrome	0.88
R0108NI	1/4-24 x 5/32" x 7/16"	'm' Nickle	1.56
0109	1/4-24 x 7/32" x 7/16"	'm' park	2.00
0109C	1/4-24 x 7/32" x 7/16"	'm' chrome	2.30
451-37	1/4-24 x 1/4" x 1/2"	park	2.00
R451-37P	1/4-24 x 1/4" x 1/2"	'm' park	1.13
R451-37	1/4-24 x 1/4" x 1/2"	'm' cad	1.13
R451-37C	1/4-24 x 1/4" x 1/2"	'm' chrome	1.56
R0111P	5/16-18 x 17/64" x 1/2"	'm' park	1.13
R0111Z	5/16-18 x 17/64" x 1/2"	zinc	0.30
R0111	5/16-18 x 17/64" x 1/2"	'm' cad	1.19
R0111C	5/16-18 x 17/64" x 1/2"	chrome	1.00
R0111NI	5/16-18 x 17/64" x 1/2"	Nickle	1.00
R0112P	5/16-24 x 17/64" x 7/16"	'm' park	1.25
R0112	5/16-24 x 17/64" x 7/16"	'm' cad	1.38
R0112NI	5/16-24 x 17/64" x 7/16"	'm' Nickle	1.50
R0117BP	5/16-24 x 3/16" x 1/2"	park	1.25
R0117B	5/16-24 x 3/16" x 1/2"	cad	1.38
R0117BC	5/16-24 x 3/16" x 1/2"	chrome	1.50
R0117P	5/16-24 x 17/64" x 1/2"	'm' park	1.19
R0117Z	5/16-24 x 17/64" x 1/2"	zinc	0.30
R0117M	5/16-24 x 17/64" x 1/2"	'm' cad	1.25
R0117C	5/16-24 x 17/64" x 1/2"	chrome	0.94
R0117NI	5/16-24 x 17/64" x 1/2"	Nickle	1.35
R7725	5/16-24 x 1/2" flexloc	cad	1.88
R7725C	5/16-24 x 1/2" flexloc	chrome	1.94
R0117A	5/16-24 x 5/16" x 9/16"	'm' park	1.44
R0120P	3/8-16 x 5/16" x 9/16"	'm' park	1.44
R0120	3/8-16 x 5/16" x 9/16"	'm' cad	1.50
R0120C	3/8-16 x 5/16" x 9/16"	'm' chrome	1.69
R0120NI	3/8-16 x 5/16" x 9/16"	'm' Nickle	1.75
R0129AP	3/8-24 x 7/32" x 9/16"	park	1.25
R0129A	3/8-24 x 7/32" x 9/16"	cad	1.25
R0129AC	3/8-24 x 7/32" x 9/16"	chrome	1.69
R0129C	3/8-24 x 7/32" x 9/16"	chrome	1.75

Nuts (continued)

0129	3/8-24 x 1/4" x 9/16"	'm' park	1.50
0129.50pack	Bag of 50 nuts	'm' park	45.00
R0129P	3/8-24 x 1/4" x 9/16"	'm' park	1.44
R0129	3/8-24 x 1/4" x 9/16"	'm' cad	1.56
0129C	3/8-24 x 1/4" x 9/16"	'm' chrome	2.50
0129Z	3/8-24 x 1/4" x 9/16"	'm' zinc	2.00
R0127P	3/8-24 x 21/64" x 9/16"	'm' park	1.50
R0127Z	3/8-24 x 21/64" x 9/16"	zinc	0.50
R0127	3/8-24 x 21/64" x 9/16"	'm' cad	1.63
R0127C	3/8-24 x 21/64" x 9/16"	chrome	1.06
R0127NI	3/8-24 x 21/64" x 9/16"	'm' Nickle	1.60
R0123P	3/8-24 x 1/2" x 9/16"	'm' park	1.50
R0123	3/8-24 x 1/2" x 9/16"	'm' cad	1.69
R0123C	3/8-24 x 1/2" x 9/16"	chrome	2.81
R0123NI	3/8-24 x 1/2" x 9/16"	'm' Nickle	1.90
2633-30A	3/8-24 x 7/32" x 5/8"	'm' bare	2.00
R0125P	3/8-24 x 1/4" x 5/8"	'm' park	1.50
R2318-36AP	3/8-24 x 21/64" x 5/8"	'm' park	1.63
R2318-36A	3/8-24 x 21/64" x 5/8"	'm' cad	1.69
R2318-36AC	3/8-24 x 21/64" x 5/8"	'm' chrome	1.88
R0128P	3/8-24 x 9/16" castle	park	2.00
R0128	3/8-24 x 9/16" castle	cad	2.13
R0128C	3/8-24 x 9/16" castle	chrome	2.31
R0128NI	3/8-24 x 9/16" castle	Nickle	2.00
3910-37	3/8-24 x 15/16" castle	park	3.00
R3910-37P	3/8-24 x 15/16" castle	park	3.44
R3910-37	3/8-24 x 15/16" castle	cad	3.44
R3910-37C	3/8-24 x 15/16" castle	chrome	4.38
R7775P	3/8-24 x 9/16" flexloc	park	2.81
R7775	3/8-24 x 9/16" flexloc	cad	2.81
R0130P	7/16-18 x 1/4" x 11/16"	'm' park	1.63
R0130	7/16-18 x 1/4" x 11/16"	'm' cad	2.06
R0130NI	7/16-18 x 1/4" x 11/16"	'm' Nickle	1.80
R4166-28P	7/16-20 x 1/4" x 9/16"	'm' park	1.75
R4166-28	7/16-20 x 1/4" x 9/16"	'm' cad	1.88
R4166-28C	7/16-20 x 1/4" x 9/16"	'm' chrome	2.50
R0136P	7/16-20 x 1/4" x 5/8"	'm' park	1.63
R0136	7/16-20 x 1/4" x 5/8"	'm' cad	1.69
R0136C	7/16-20 x 1/4" x 5/8"	'm' chrome	1.75
R0133P	7/16-20 x 3/8" x 5/8"	'm' park	1.63
R0133	7/16-20 x 3/8" x 5/8"	'm' cad	1.69
R0133C	7/16-20 x 3/8" x 5/8"	'm' chrome	1.88
0134	7/16-20 x 1/2" x 5/8"	'm' park	2.00
R0134P	7/16-20 x 1/2" x 5/8"	'm' park	1.69
R0134	7/16-20 x 1/2" x 5/8"	'm' cad	1.81
R0134C	7/16-20 x 1/2" x 5/8"	'm' chrome	3.13
R0134NI	7/16-20 x 1/2" x 5/8"	'm' Nickle	2.50
0138	7/16-20 x 5/8" castle	cad	3.20
R7825P	7/16-20 x 5/8" flexlock	park	3.75
R7825	7/16-20 x 5/8" flexlock	cad	3.94
R7872	7/16-20 x 5/8" red cap		
R7872B	7/16-20 x 5/8" black cap		2.00
R7863	7/16-20 x 3/8" x 3/4"	'm' cad	
R7863C	7/16-20 x 3/8" x 3/4"	'm' chrome	2.25
R2644-30P	7/16-20 x 7/16" x 3/4"	'm' park	2.50
R2644-30	7/16-20 x 7/16" x 3/4"	'm' cad	2.50
R2644-30C	7/16-20 x 7/16" x 3/4"	'm' chrome	3.44
2641-30	7/16-20 x 9/32" x 13/16"	'm' park	2.00
2641-30C	7/16-20 x 9/32" x 13/16"	'm' chrome	3.00
R4079-26P	7/16-20 x 13/32" x 13/16"	'm' park	5.94
R4079-26	7/16-20 x 13/32" x 13/16"	'm' cad	5.94
0131	7/16-24 x 1/4" x 3/4"	'm' park	2.00
0135A	1/2-13 x 1/2" x 7/8"	zinc	
R2634-30AP	1/2-20 x 3/8" x 3/4"	'm' park	2.50
R2634-30A	1/2-20 x 3/8" x 3/4"	'm' cad	2.50
R2634-30AC	1/2-20 x 3/8" x 3/4"	'm' chrome	3.44

Nuts (continued)

R2634-36	1/2-20 x 3/4 acorn nut	park	5.00
R2634-36C	1/2-20 x 3/4 acorn nut	chrome	5.63
R2643-31	1/2-20 x 5/16" x 13/16" 'm'	park	2.13
R2643-31cad	1/2-20 x 5/16" x 13/16" 'm'	cad	2.19
R6032-36P	1/2-20 x 7/16" x 7/8" 'm'	park	2.25
7914	1/2-20 x 7/16" x 7/8"	zinc	4.00
7907	1/2-20 x 7/16" x 7/8" 'm'	bare	3.00
R4178-42P	1/2-20 x 7/8" castle nut	park	6.25
R4178-42	1/2-20 x 7/8" castle nut	cad	7.50
R4178-42C	1/2-20 x 7/8" castle nut	chrome	9.38
R7926	1/2-20 x 9/32" x 1-3/16" 'm'		
R6036-36BP	9/16-18 x 11/32" x 15/16" 'm'	park	3.13
R6036-36B	9/16-18 x 11/32" x 15/16" 'm'	cad	3.31
R3996-36P	5/8-18 x 7/16" x 7/8" 'm'	park	3.13
R3996-36	5/8-18 x 7/16" x 7/8" 'm'	cad	3.38
R3996-36C	5/8-18 x 7/16" x 7/8" 'm'	chrome	5.00
R7974P	5/8-18 x 7/32" x 15/16" 'm'	park	
R7974	5/8-18 x 7/32" x 15/16" 'm'	cad	3.13
364-29	5/8-18 x 7/32" x 15/16" 'm'		8.00
R364-29	5/8-18 x 7/32" x 15/16" 'm'		6.50
R2274-36	5/8-18 x 7/32" x 1" 'm'		3.25

Nuts (continued)

2050-12	5/8-18 x 5/16" x 1-1/16" 'm'	park	7.00
0142	5/8 -24 x 7/32" x 7/8" 'm'	park	3.00
R2050-30	11/16-18 x 1" special	'm' park	13.75
364-37	11/16-18 x 7/32" x 1-1/16" 'm'		4.00
R8011	11/16-18 x 7/32" x 1-3/16" 'm'		5.50
3929-44	11/16-24 x 15/16" special	'm' park	6.00
R3929-44P	11/16-24 x 15/16" special	'm' park	8.75
R3929-44	11/16-24 x 15/16" special	'm' cad	8.75
R3929-44C	11/16-24 x 15/16" special	'm' chrome	11.25
R8025	3/4-16 x 11/16" x 1-1/16" 'm'		8.75
2932-14	3/4-18 x 7/16" x 1-1/16" 'm'	park	6.00
R364-36	3/4-18 x 9/32" x 1-3/16" 'm'		8.50
R365-15	13/16-18 x 1/4" x 1-3/16" 'm'		11.56
R4005-35P	13/16-24 x 19/64" x 1-3/16" 'm'	park	13.75
R4005-35	13/16-24 x 19/64" x 1-3/16" 'm'	cad	13.75
R4005-35C	13/16-24 x 19/64" x 1-3/16" 'm'	chrome	15.94
R4184-30P	13/16-24 x 3/8" x 1-3/16" 'm'	park	7.50
R4184-30	13/16-24 x 3/8" x 1-3/16" 'm'	cad	8.13
R4184-30C	13/16-24 x 3/8" x 1-3/16" 'm'	chrome	10.00

Washers

Listed by size:

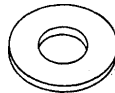

R6189W	5/32" x 25/64" x .032"	brass	0.35
R0202A	3/16" x 21/64" x 1/64"	zinc	0.40
R0201P	3/16" x 7/16" x 1/32"	park	0.31
R0201	3/16" x 7/16" x 1/32"	zinc	0.38
R0201A	13/64" x 3/8" x 1/32"	brass	0.50
R0205P	7/32" x 1/2" x 1/16"	park	0.38
0207	1/4" x 7/16" x 1/32"	park	1.00
R6099	1/4" x 7/16" x 1/16"	zinc	0.40
R6099C	1/4" x 7/16" x 1/16"	chrome	0.44
1417-42	1/4" x 1/2" x 1/16"		0.80
R0208AP	1/4" x 9/16" x 1/16"	park	0.38
R0207B	1/4" x 9/16" x 1/32"	zinc	0.30
R0208P	1/4" x 5/8" x 1/16"	park	0.38
R0208Z	1/4" x 5/8" x 1/16"	zinc	0.30
R0208C	1/4" x 5/8" x 1/16"	chrome	0.50
R0208NI	1/4" x 5/8" x 1/16"	Nickle	0.50
R0211P	9/32" x 15/32" x 1/32"	park	0.63
R0213P	5/16" x 1/2" x 3/32"	park	0.50
R0213NI	5/16" x 1/2" x 3/32"	Nickle	0.63
R0212P	5/16" x 9/16" x 1/32"	park	0.50
R0212	5/16" x 9/16" x 1/32"	stainless	0.30
R0212C	5/16" x 9/16" x 1/32"	chrome	
R6316WP	5/16" x 5/8" x 1/16"	park	0.31
R6316W	5/16" x 5/8" x 1/16"	cad/zinc	0.38
R6316WC	5/16" x 5/8" x 1/16"	chrome	0.50
R0214P	5/16" x 11/16" x 1/16"	park	0.50
R0214	5/16" x 11/16" x 1/16"	cad	0.50
R0214C	5/16" x 11/16" x 1/16"	chrome	0.65
6327B	5/16" x 3/4" x 1/16"	park	2.00
R6327B	5/16" x 3/4" x 1/16"	zinc	0.30
R0215P	5/16" x 15/16" x 1/16"	park	0.63
R0212AP	21/64" x 15/16" x 3/16"	park	1.13
R2788-30	3/8" x 9/16" x 1/16"	park	1.00
R6377	3/8" x 5/8" x 1/32"	brass	0.50
R0226P	3/8" x 5/8" x 3/64"	park	0.63
R0224AP	3/8" x 23/32" x 1/16"	park	0.63

Washers (continued)

R0224P	3/8" x 13/16" x 1/16"	park	0.63
R0224	3/8" x 13/16" x 1/16"	cad	0.63
R0224C	3/8" x 13/16" x 1/16"	chrome	0.88
R0224NI	3/8" x 13/16" x 1/16"	Nickle	0.70
R0225P	3/8" x 13/16" x 7/64"	park	0.63
R0223AP	3/8" x 7/8" x 1/8"	park	1.13
R0223A	3/8" x 7/8" x 1/8"	cad	1.13
R0223AC	3/8" x 7/8" x 1/8"	chrome	1.38
R0223P	3/8" x 1" x 1/8"	park	1.13
R0223	3/8" x 1" x 1/8"	cad	1.13
R0223C	3/8" x 1" x 1/8"	chrome	1.50
R13457-40P	3/8" x 1-1/8" x 1/8"	park	1.25
R13457-40cad	3/8" x 1-1/8" x 1/8"	cad	1.38
R13457-40C	3/8" x 1-1/8" x 1/8"	chrome	3.13
R0227AP	25/64" x 13/16" x 1/8"	park	0.75
3572-36C	13/32" x 5/8" x 13/32"	park	0.60
R3572-36C	13/32" x 5/8" x 13/32"	brass	0.50
2952-35	13/32" x 11/16" x 1/4"	park	2.50
0228	7/16" x 21/32" x 1/16"	park	1.50
R2242-36B	7/16" x 3/4" x 1/64"	zinc	0.50
R15-36P	7/16" x 3/4" x 1/8"	park	0.75
R15-36	7/16" x 3/4" x 1/8"	cad	0.75
R15-36C	7/16" x 3/4" x 1/8"	chrome	1.06
R0232P	7/16" x 13/16" x 3/32"	park	0.88
0232	7/16" x 13/16" x 3/32"	cad	1.50
R0232C	7/16" x 13/16" x 3/32"	chrome	1.25
0230	7/16" x 15/16" x 1/8"	park	2.00
R0230P	7/16" x 15/16" x 1/8"	park	1.06
R0230	7/16" x 15/16" x 1/8"	cad	1.06
R0230C	7/16" x 15/16" x 1/8"	chrome	1.25
R0234	29/64" x 1-1/8" x .015"		0.75
R0231P	29/64" x 1-1/8" x 3/32"	park	1.25
0231W	29/64" x 1-1/8" x 3/32"	cad	
R1643-29	15/32" x 3/4" x .033"		0.80
R1643-29S	15/32" x 3/4" x .070"		0.80
1643-30	15/32" x 3/4" x .072"	park	2.00
R13458-36P	1/2" x 1-1/8" x 3/32"	park	1.25
R13458-36cad	1/2" x 1-1/8" x 3/32"	cad	1.38
R13458-36C	1/2" x 1-1/8" x 3/32"	chrome	1.75
R6581	17/32" x 15/16" x .025"	brass	0.95

Screws, Bolts, Nuts

Lockwashers

Listed by size:

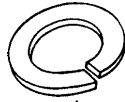

R0250	No.4 x 17/64" x 1/32"	zinc	0.20
R0251	No.6 x 15/64" x 1/32"	zinc	0.20
R0252P	No.8 x 5/32" x 1/32"	park	0.25
R0252	No.8 x 5/32" x 1/32"	zinc	0.20
R0252C	No.8 x 5/32" x 1/32"	chrome	0.38
R0254P	No.10 x 21/64" x 3/64"	park	0.25
R0254	No.10 x 21/64" x 3/64"	zinc	0.20
R0254C	No.10 x 21/64" x 3/64"	chrome	0.38
0253	3/16" x 3/8" x 3/64"	park	0.25
R0255P	No.12 x 11/32" x 3/64"	park	0.25
R0255	No.12 x 11/32" x 3/64"	zinc	0.20
0255A	7/32" x 15/32" x 3/64"	park	1.30
R0256P	1/4" x 1/2" x 1/16"	park	0.25
R0256	1/4" x 1/2" x 1/16"	zinc	0.25
R0256C	1/4" x 1/2" x 1/16"	chrome	0.38
R0259P	5/16" x 9/16" x 1/16"	park	0.25
R0259	5/16" x 9/16" x 1/16"	zinc	0.25
R0259C	5/16" x 9/16" x 1/16"	chrome	0.38
R0261B	3/8" x 5/8" x 3/32"	black	0.20
R0261P	3/8" x 5/8" x 3/32"	park	0.25
R0261	3/8" x 5/8" x 1/16"	zinc	0.25
R0261C	3/8" x 5/8" x 3/32"	chrome	0.38
R0262P	3/8" x 13/16" x 1/16"	park	4.38
R0265P	7/16" x 11/16" x 3/32"	park	0.69
R0265	7/16" x 11/16" x 3/32"	zinc	0.75
R0265C	7/16" x 11/16" x 3/32"	chrome	0.94
R0265AP	7/16" x 3/4" x 3/32"	park	1.06
R0265A	7/16" x 3/4" x 3/32"	zinc	0.30
R0265AC	7/16" x 3/4" x 3/32"	chrome	0.69
R0266P	7/16" x 3/4" x 1/8"	park	0.75
R0266	7/16" x 3/4" x 1/8"	cad	0.75
R0266C	7/16" x 3/4" x 1/8"	chrome	0.85
0266	7/16" x 13/16" x 3/32"	park	1.50
R0269P	9/16" x 15/16" x 3/32"	park	1.50
R0269	9/16" x 15/16" x 3/32"	zinc	0.30
R7043	3/4" x 1-1/4" x 3/16"	zinc	0.50

0253, 0255A, 0262, 0266 are special lockwashers (larger o.d.)

Special Lockwashers

Listed by size:

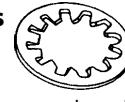

R7206W	No.4	external tooth	zinc	0.20
R0351	No.6	internal tooth	zinc	0.20
R7143	No.8	external tooth	zinc	0.30
R0352	No.8	internal tooth	zinc	0.20
R0353	No.8	external-internal	zinc	0.25
R0354	No.10	external tooth	zinc	0.20
R0356	No.10	internal tooth	zinc	0.20
R7121	No.12	internal tooth	zinc	0.20
R0359	1/4"	internal tooth	zinc	0.20
R0363P	1/4"	external tooth	park	0.38
R0363	1/4"	external tooth	zinc	0.20
R7229W	1/4"	external-internal	zinc	0.35
R0365P	1/4"	countersunk	park	0.38
R0365	1/4"	countersunk	zinc	0.25
R0360	5/16"	internal tooth	zinc	0.20
R7232	5/16"	external tooth	zinc	0.20
R0370P	5/16"	countersunk	park	0.50
R0370	5/16"	countersunk	zinc	0.30
R7042	5/16"	high collar	zinc	0.30
R0374	3/8"	internal tooth	zinc	0.20
R7145W	3/8"	external tooth	zinc	0.25
R6027W	3/8"	countersunk	zinc	0.35
R7045	3/8"	high collar	zinc	0.30
R0362	7/16"	internal tooth	zinc	0.20
R7129	1/2"	internal tooth	zinc	0.25
R0390	1/2"	external tooth	zinc	0.25
R7242	5/8"	external tooth	zinc	0.30
R7142	3/4"	internal tooth	zinc	0.30
R7144	3/4"	external tooth	zinc	0.30

Steel Balls



R1297-26	5/32" steel ball	0.35
R0279	3/16" steel ball	
R2472-41B	7/32" steel ball	0.20
R0280	1/4" steel ball	0.20
R0282	5/16" steel ball	0.30
R704-36	3/8" steel ball	0.40
R2251-36	1/2" steel ball	1.00

Grease Fittings



R0340	Alemite fitting	'24-'37	Nickle	3.75
R0344	Grease nipple	straight	zinc	2.63
R0344C	Grease nipple	straight	chrome	2.75
R0344P	Grease nipple	straight	park	2.63
0345	Grease nipple	67.5° angle	cad	3.00
R0347	Grease nipple	90° angle	zinc	2.00

Rivets



1647-31A	1/8" x 9/32"	brass	tubular	0.50
4046-31	9/64" x 9/32"	brass	tubular	0.30
R4033-35	5/32" x 1/2"	steel	round head	0.25
2485-41A	3/16" x 7/32"	brass	countersunk	0.20
R2485-41	3/16" x 9/32"	brass	countersunk	n.a.
2485-40	3/16" x 3/8"	brass	countersunk	0.20
0306	3/16" x 5/16"	steel	round head	0.50
R0308	3/16" x 9/16"	steel	round head	0.35
0314	3/16" x 3/8"	steel	truss head	1.00

Cotter Pins

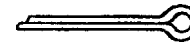

R551	3/64" x 9/16"	zinc	0.20
R0290P	1/16" x 1/2"	park	0.19
R0290	1/16" x 1/2"	zinc	0.15
R0296	1/16" x 5/8"	zinc	0.15
R0297	1/16" x 3/4"	zinc	0.15
R0291P	3/32" x 5/8"	park	0.19
R0291	3/32" x 5/8"	zinc	0.15
R0298	3/32" x 7/8"	zinc	0.15
513	3/32" x 15/16"	zinc	0.60
R0292P	3/32" x 1"	park	0.25
R0292	3/32" x 1"	zinc	0.15
R0293	1/8" x 5/8"	zinc	0.15
R0294	1/8" x 1-1/4"	zinc	0.20
R511	9/64" x 1-1/4"	zinc	0.25
R0295	3/16" x 1"	zinc	0.25



Round head machine screw, zinc

H01044005	4-40 x 1/4"	0.30
H01044007	4-40 x 3/8"	0.30
H01044010	4-40 x 1/2"	0.30
H01044012	4-40 x 5/8"	0.30
H01044015	4-40 x 3/4"	0.30
H01054005	5-40 x 1/4"	0.30
H01054010	5-40 x 1/2"	0.30
H01063205	6-32 x 1/4"	0.30
H01063207	6-32 x 3/8"	0.30
H01063210	6-32 x 1/2"	0.30
H01063212	6-32 x 5/8"	0.30
H01063215	6-32 x 3/4"	0.30
H01063220	6-32 x 1"	0.30
H01063225	6-32 x 1 1/4"	0.30
H01063230	6-32 x 1 1/2"	0.30
H01083205	8-32 x 1/4"	0.30
H01083207	8-32 x 3/8"	0.30
H01083210	8-32 x 1/2"	0.30
H01083212	8-32 x 5/8"	0.30
H01083215	8-32 x 3/4"	0.30
H01083217	8-32 x 7/8"	0.30
H01083220	8-32 x 1"	0.50
H01083225	8-32 x 1 1/4"	0.50
H01083230	8-32 x 1 1/2"	0.50
H01102407	10-24 x 3/8"	0.30
H01102410	10-24 x 1/2"	0.30
H01102412	10-24 x 5/8"	0.30
H01102415	10-24 x 3/4"	0.30
H01102420	10-24 x 1"	0.50
H01102425	10-24 x 1 1/4"	0.50
H01102430	10-24 x 1 1/2"	0.50
H01102435	10-24 x 1 3/4"	0.50
H01102440	10-24 x 2"	0.50
H01103207	10-32 x 3/8"	0.30
H01103210	10-32 x 1/2"	0.30
H01103212	10-32 x 5/8"	0.30
H01103215	10-32 x 3/4"	0.30
H01103220	10-32 x 1"	0.50
H01103225	10-32 x 1 1/4"	0.50
H01103230	10-32 x 1 1/2"	0.50
H01103235	10-32 x 1 3/4"	0.50
H01103240	10-32 x 2"	0.50
H01122407	12-24 x 3/8"	0.30
H01122410	12-24 x 1/2"	0.30
H01122412	12-24 x 5/8"	0.30
H01122415	12-24 x 3/4"	0.30
H01122420	12-24 x 1"	0.50

Flat head machine screw, zinc

H02044007	4-40 x 3/8"	0.30
H02044010	4-40 x 1/2"	0.30
H02044012	4-40 x 5/8"	0.30
H02044015	4-40 x 3/4"	0.30
H02063207	6-32 x 3/8"	0.30
H02063210	6-32 x 1/2"	0.30
H02063212	6-32 x 5/8"	0.30
H02063215	6-32 x 3/4"	0.30
H02063220	6-32 x 1"	0.30
H02083207	8-32 x 3/8"	0.30
H02083210	8-32 x 1/2"	0.30
H02083212	8-32 x 5/8"	0.30
H02083215	8-32 x 3/4"	0.30
H02083220	8-32 x 1"	0.30
H02102410	10-24 x 1/2"	0.30
H02102412	10-24 x 5/8"	0.30
H02102415	10-24 x 3/4"	0.30
H02102420	10-24 x 1"	0.30
H02102425	10-24 x 1 1/4"	0.30
H02103210	10-32 x 1/2"	0.30
H02103212	10-32 x 5/8"	0.30
H02103215	10-32 x 3/4"	0.30
H02103220	10-32 x 1"	0.30
H02103225	10-32 x 1 1/4"	0.30

Flat head sheet metal screws, zinc

H03040007	4 x 3/8"	0.30
H03040010	4 x 1/2"	0.30
H03040012	4 x 5/8"	0.30
H03060007	6 x 3/8"	0.30
H03060010	6 x 1/2"	0.30
H03060012	6 x 5/8"	0.30
H03060015	6 x 3/4"	0.30
H03060020	6 x 1"	0.30
H03080007	8 x 3/8"	0.30
H03080010	8 x 1/2"	0.30
H03080012	8 x 5/8"	0.30
H03080015	8 x 3/4"	0.30
H03080020	8 x 1"	0.30
H03100010	10 x 1/2"	0.30
H03100015	10 x 3/4"	0.30
H03100020	10 x 1"	0.30
H03100025	10 x 1 1/4"	0.30
H03120010	12 x 1/2"	0.30
H03120015	12 x 3/4"	0.30
H03120020	12 x 1"	0.30
H03140010	14 x 1/2"	0.30
H03140015	14 x 3/4"	0.30
H03140020	14 x 1"	0.30



Pan head sheet metal screws, zinc

H04040007	4 x 3/8"	0.30
H04040010	4 x 1/2"	0.30
H04040012	4 x 5/8"	0.30
H04060007	6 x 3/8"	0.30
H04060010	6 x 1/2"	0.30
H04060012	6 x 5/8"	0.30
H04060015	6 x 3/4"	0.30
H04060020	6 x 1"	0.30
H04080007	8 x 3/8"	0.30
H04080010	8 x 1/2"	0.30
H04080012	8 x 5/8"	0.30
H04080015	8 x 3/4"	0.30
H04080020	8 x 1"	0.30
H04100010	10 x 1/2"	0.30
H04100012	10 x 5/8"	0.30
H04100015	10 x 3/4"	0.30
H04100020	10 x 1"	0.30
H04100025	10 x 1 1/4"	0.30
H04120010	12 x 1/2"	0.30
H04120015	12 x 3/4"	0.30
H04120020	12 x 1"	0.30
H04140010	14 x 1/2"	0.30
H04140015	14 x 3/4"	0.30
H04140020	14 x 1"	0.30



Hex head bolt, stainless steel

H06142012	1/4-20 x 5/8"	1.50
H06142015	1/4-20 x 3/4"	1.50
H06142017	1/4-20 x 7/8"	1.50
H06142020	1/4-20 x 1"	1.50
H06142025	1/4-20 x 1-1/4"	1.70
H06142030	1/4-20 x 1-1/2"	1.70
H06142035	1/4-20 x 1-3/4"	1.70
H06142040	1/4-20 x 2"	1.70
H06142045	1/4-20 x 2-1/4"	1.70
H06142812	1/4-28 x 5/8"	1.50
H06142815	1/4-28 x 3/4"	1.50
H06142817	1/4-28 x 7/8"	1.50
H06142820	1/4-28 x 1"	1.50
H06142825	1/4-28 x 1-1/4"	1.70
H06142830	1/4-28 x 1-1/2"	1.70
H06142835	1/4-28 x 1-3/4"	1.70
H06142840	1/4-28 x 2"	1.70

H06142845	1/4-28 x 2-1/4"	1.70
H06161812	5/16-18 x 5/8"	1.50
H06161815	5/16-18 x 3/4"	1.50
H06161817	5/16-18 x 7/8"	1.50
H06161820	5/16-18 x 1"	1.50
H06161825	5/16-18 x 1-1/4"	1.70
H06161830	5/16-18 x 1-1/2"	1.70
H06161835	5/16-18 x 1-3/4"	1.70
H06161840	5/16-18 x 2"	1.70
H06161845	5/16-18 x 2-1/4"	1.70
H06162412	5/16-24 x 5/8"	1.50
H06162415	5/16-24 x 3/4"	1.50
H06162417	5/16-24 x 7/8"	1.50
H06162420	5/16-24 x 1"	1.50
H06162425	5/16-24 x 1-1/4"	1.70
H06162430	5/16-24 x 1-1/2"	1.70
H06162435	5/16-24 x 1-3/4"	1.70

H06162440	5/16-24 x 2"	1.70
H06162445	5/16-24 x 2-1/4"	1.70
H06181615	3/8-16 x 3/4"	1.50
H06181620	3/8-16 x 1"	1.50
H06181625	3/8-16 x 1-1/4"	1.70
H06181630	3/8-16 x 1-1/2"	1.70
H06181635	3/8-16 x 1-3/4"	1.70
H06181640	3/8-16 x 2"	1.70
H06182415	3/8-24 x 3/4"	1.50
H06182420	3/8-24 x 1"	1.50
H06182425	3/8-24 x 1-1/4"	1.70
H06182430	3/8-24 x 1-1/2"	1.70
H06182435	3/8-24 x 1-3/4"	1.70
H06182440	3/8-24 x 2"	1.70



Standard Hardware

Hex head bolt, zinc

H07142010	1/4-20 x 1/2"	0.50	H07162417	5/16-24 x 7/8"	0.50	H07182470	3/8-24 x 3-1/2"	0.80
H07142012	1/4-20 x 5/8"	0.50	H07162420	5/16-24 x 1"	0.50	H07182475	3/8-24 x 3-3/4"	0.80
H07142015	1/4-20 x 3/4"	0.50	H07162425	5/16-24 x 1-1/4"	0.50	H07201415	7/16-14 x 3/4"	1.30
H07142017	1/4-20 x 7/8"	0.50	H07162430	5/16-24 x 1-1/2"	0.50	H07201420	7/16-14 x 1"	1.30
H07142020	1/4-20 x 1"	0.50	H07162435	5/16-24 x 1-3/4"	0.70	H07201425	7/16-14 x 1-1/4"	1.30
H07142025	1/4-20 x 1-1/4"	0.50	H07162440	5/16-24 x 2"	0.70	H07201430	7/16-14 x 1-1/2"	1.30
H07142030	1/4-20 x 1-1/2"	0.50	H07162445	5/16-24 x 2-1/4"	0.70	H07201435	7/16-14 x 1-3/4"	1.60
H07142035	1/4-20 x 1-3/4"	0.70	H07162450	5/16-24 x 2-1/2"	0.70	H07201440	7/16-14 x 2"	1.60
H07142040	1/4-20 x 2"	0.70	H07162455	5/16-24 x 2-3/4"	0.70	H07201445	7/16-14 x 2-1/4"	1.60
H07142045	1/4-20 x 2-1/4"	0.70	H07181610	3/8-16 x 1/2"	0.70	H07201450	7/16-14 x 2-1/2"	1.60
H07142050	1/4-20 x 2-1/2"	0.70	H07181612	3/8-16 x 5/8"	0.70	H07201455	7/16-14 x 2-3/4"	1.60
H07142055	1/4-20 x 2-3/4"	0.70	H07181615	3/8-16 x 3/4"	0.70	H07202015	7/16-20 x 3/4"	1.30
H07142810	1/4-28 x 1/2"	0.50	H07181617	3/8-16 x 7/8"	0.70	H07202020	7/16-20 x 1"	1.30
H07142812	1/4-28 x 5/8"	0.50	H07181620	3/8-16 x 1"	0.80	H07202025	7/16-20 x 1-1/4"	1.30
H07142815	1/4-28 x 3/4"	0.50	H07181625	3/8-16 x 1-1/4"	0.80	H07202030	7/16-20 x 1-1/2"	1.30
H07142817	1/4-28 x 7/8"	0.50	H07181630	3/8-16 x 1-1/2"	0.80	H07202035	7/16-20 x 1-3/4"	1.60
H07142820	1/4-28 x 1"	0.50	H07181635	3/8-16 x 1-3/4"	0.80	H07202040	7/16-20 x 2"	1.60
H07142825	1/4-28 x 1-1/4"	0.50	H07181640	3/8-16 x 2"	0.80	H07202045	7/16-20 x 2-1/4"	1.60
H07142830	1/4-28 x 1-1/2"	0.50	H07181645	3/8-16 x 2-1/4"	0.80	H07202050	7/16-20 x 2-1/2"	1.60
H07142835	1/4-28 x 1-3/4"	0.70	H07181650	3/8-16 x 2-1/2"	0.80	H07202055	7/16-20 x 2-3/4"	1.60
H07142840	1/4-28 x 2"	0.70	H07181655	3/8-16 x 2-3/4"	0.80	H07202060	7/16-20 x 3"	1.60
H07142845	1/4-28 x 2-1/4"	0.70	H07181660	3/8-16 x 3"	0.80	H07221315	1/2-13 x 3/4"	1.30
H07142850	1/4-28 x 2-1/2"	0.70	H07181665	3/8-16 x 3-1/4"	0.80	H07221320	1/2-13 x 1"	1.30
H07142855	1/4-28 x 2-3/4"	0.70	H07181670	3/8-16 x 3-1/2"	0.80	H07221325	1/2-13 x 1-1/4"	1.30
H07161812	5/16-18 x 5/8"	0.50	H07181675	3/8-16 x 3-3/4"	0.80	H07221330	1/2-13 x 1-1/2"	1.30
H07161815	5/16-18 x 3/4"	0.50	H07182410	3/8-24 x 1/2"	0.70	H07221335	1/2-13 x 1-3/4"	1.60
H07161817	5/16-18 x 7/8"	0.50	H07182412	3/8-24 x 5/8"	0.70	H07221340	1/2-13 x 2"	1.60
H07161820	5/16-18 x 1"	0.50	H07182415	3/8-24 x 3/4"	0.70	H07221345	1/2-13 x 2-1/4"	1.60
H07161825	5/16-18 x 1-1/4"	0.50	H07182417	3/8-24 x 7/8"	0.70	H07221350	1/2-13 x 2-1/2"	1.60
H07161830	5/16-18 x 1-1/2"	0.50	H07182420	3/8-24 x 1"	0.80	H07221355	1/2-13 x 2-3/4"	1.60
H07161835	5/16-18 x 1-3/4"	0.70	H07182425	3/8-24 x 1-1/4"	0.80	H07221360	1/2-13 x 3"	1.60
H07161840	5/16-18 x 2"	0.70	H07182430	3/8-24 x 1-1/2"	0.80	H07221365	1/2-13 x 3-1/4"	1.60
H07161845	5/16-18 x 2-1/4"	0.70	H07182435	3/8-24 x 1-3/4"	0.80	H07222020	1/2-20 x 1"	1.30
H07161850	5/16-18 x 2-1/2"	0.70	H07182440	3/8-24 x 2"	0.80	H07222025	1/2-20 x 1-1/4"	1.30
H07161855	5/16-18 x 2-3/4"	0.70	H07182445	3/8-24 x 2-1/4"	0.80	H07222030	1/2-20 x 1-1/2"	1.30
H07161860	5/16-18 x 3"	0.70	H07182450	3/8-24 x 2-1/2"	0.80	H07222035	1/2-20 x 1-3/4"	1.60
H07162410	5/16-24 x 1/2"	0.50	H07182455	3/8-24 x 2-3/4"	0.80	H07222040	1/2-20 x 2"	1.60
H07162412	5/16-24 x 5/8"	0.50	H07182460	3/8-24 x 3"	0.80	H07222045	1/2-20 x 2 1/4"	1.60
H07162415	5/16-24 x 3/4"	0.50	H07182465	3/8-24 x 3-1/4"	0.80	H07222050	1/2-20 x 2 1/2"	1.60
						H07222055	1/2-20 x 2 3/4"	1.60
						H07222060	1/2-20 x 3"	1.60

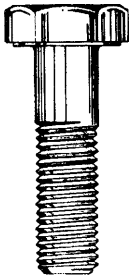

Hex head bolt, chrome plated

H05142012	1/4-20 x 5/8"	1.70	H05161845	5/16-18 x 2 1/4"	2.00	H05201430	7/16-14 x 1-1/2"	2.20
H05142015	1/4-20 x 3/4"	1.70	H05162410	5/16-24 x 1/2"	1.70	H05201435	7/16-14 x 1-3/4"	2.20
H05142017	1/4-20 x 7/8"	1.70	H05162412	5/16-24 x 5/8"	1.70	H05201440	7/16-14 x 2"	2.20
H05142020	1/4-20 x 1"	1.70	H05162415	5/16-24 x 3/4"	1.70	H05202020	7/16-20 x 1"	2.00
H05142025	1/4-20 x 1-1/4"	2.00	H05162417	5/16-24 x 7/8"	1.70	H05202025	7/16-20 x 1-1/4"	2.00
H05142030	1/4-20 x 1-1/2"	2.00	H05162420	5/16-24 x 1"	1.70	H05202030	7/16-20 x 1-1/2"	2.20
H05142035	1/4-20 x 1-3/4"	2.00	H05162425	5/16-24 x 1-1/4"	2.00	H05202035	7/16-20 x 1-3/4"	2.20
H05142040	1/4-20 x 2"	2.00	H05162430	5/16-24 x 1-1/2"	2.00	H05202040	7/16-20 x 2"	2.20
H05142045	1/4-20 x 2-1/4"	2.00	H05162435	5/16-24 x 1-3/4"	2.00	H05221315	1/2-13 x 3/4"	2.00
H05142812	1/4-28 x 5/8"	1.70	H05162440	5/16-24 x 2"	2.00	H05221325	1/2-13 x 1-1/4"	2.00
H05142815	1/4-28 x 3/4"	1.70	H05162445	5/16-24 x 2-1/4"	2.00	H05221330	1/2-13 x 1-1/2"	2.20
H05142817	1/4-28 x 7/8"	1.70	H05181615	3/8-16 x 3/4"	1.70	H05221340	1/2-13 x 2"	2.20
H05142820	1/4-28 x 1"	1.70	H05181620	3/8-16 x 1"	1.70	H05221345	1/2-13 x 2-1/4"	2.20
H05142825	1/4-28 x 1-1/4"	2.00	H05181625	3/8-16 x 1-1/4"	2.00	H05221350	1/2-13 x 2-1/2"	2.20
H05142830	1/4-28 x 1-1/2"	2.00	H05181630	3/8-16 x 1-1/2"	2.00	H05221355	1/2-13 x 2-3/4"	2.20
H05142835	1/4-28 x 1-3/4"	2.00	H05181635	3/8-16 x 1-3/4"	2.00	H05222020	1/2-20 x 1"	2.00
H05142840	1/4-28 x 2"	2.00	H05181640	3/8-16 x 2"	2.00	H05222030	1/2-20 x 1-1/2"	2.20
H05142845	1/4-28 x 2-1/4"	2.00	H05182415	3/8-24 x 3/4"	1.70	H05222035	1/2-20 x 1-3/4"	2.20
H05161812	5/16-18 x 5/8"	1.70	H05182420	3/8-24 x 1"	1.70	H05222040	1/2-20 x 2"	2.20
H05161815	5/16-18 x 3/4"	1.70	H05182425	3/8-24 x 1-1/4"	2.00	H05222045	1/2-20 x 2-1/4"	2.20
H05161817	5/16-18 x 7/8"	1.70	H05182430	3/8-24 x 1-1/2"	2.00	H05222050	1/2-20 x 2-1/2"	2.20
H05161820	5/16-18 x 1"	1.70	H05182435	3/8-24 x 1-3/4"	2.00	H05222055	1/2-20 x 2-3/4"	2.20
H05161825	5/16-18 x 1-1/4"	2.00	H05182440	3/8-24 x 2"	2.00			
H05161830	5/16-18 x 1-1/2"	2.00	H05201420	7/16-14 x 1"	2.00			
H05161835	5/16-18 x 1-3/4"	2.00	H05201425	7/16-14 x 1-1/4"	2.00			
H05161840	5/16-18 x 2"	2.00						

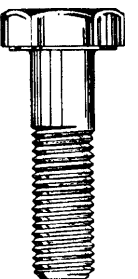

Hex nut, zinc			Hex nuts, chrome			Hex nuts, stainless steel		
H20044005	4-40 x 1/4"	0.20	H24142008	1/4-20 x 7/16"	0.75	H21063206	6-32 x 5/16"	0.50
H20063206	6-32 x 5/16"	0.20	H24142808	1/4-28 x 7/16"	0.75	H21083206	8-32 x 11/32"	0.50
H20083206	8-32 x 11/32"	0.20	H24161810	5/16-18 x 1/2"	0.88	H21102407	10-24 x 3/8"	0.50
H20102407	10-24 x 3/8"	0.20	H24162410	5/16-24 x 1/2"	0.88	H21103207	10-32 x 3/8"	0.50
H20103207	10-32 x 3/8"	0.20	H24181611	3/8-16 x 9/16"	1.00	H21142008	1/4-20 x 7/16"	0.50
H20122408	12-24 x 7/16"	0.20	H24182411	3/8-24 x 9/16"	1.00	H21142808	1/4-28 x 7/16"	0.50
H20142008	1/4-20 x 7/16"	0.20	H24201412	7/16-14 x 5/8"	1.00	H21161810	5/16-18 x 1/2"	0.50
H20142808	1/4-28 x 7/16"	0.20	H24202012	7/16-20 x 5/8"	1.00	H21162410	5/16-24 x 1/2"	0.50
H20161810	5/16-18 x 1/2"	0.20	H24222015	1/2-20 x 3/4"	1.25	H21181611	3/8-16 x 9/16"	0.60
H20162410	5/16-24 x 1/2"	0.20	H24261818	5/8-18 x 15/16"	1.50	H21182411	3/8-24 x 9/16"	0.60
H20181611	3/8-16 x 9/16"	0.30				H21202014	7/16-20 x 11/16"	0.60
H20182411	3/8-24 x 9/16"	0.30				H21222015	1/2-20 x 3/4"	1.00
H20201414	7/16-14 x 11/16"	0.30				H21261818	5/8-18 x 15/16"	2.00
H20202014	7/16-20 x 11/16"	0.30						
H20221315	1/2-13 x 3/4"	0.30						
H20222015	1/2-20 x 3/4"	0.30						
H20261118	5/8-11 x 15/16"	0.30						
H20261818	5/8-18 x 15/16"	0.30						
H20301022	3/4-10 x 1 1/8"	0.30						
H20301622	3/4-16 x 1 1/8"	0.30						

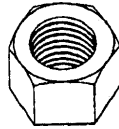



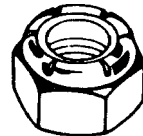

Nylock nuts, zinc			Nylock nuts, chrome		
H22044005	4-40 x 1/4"	0.30	H23102407	10-24 x 3/8"	0.88
H22063206	6-32 x 5/16"	0.30	H23103207	10-32 x 3/8"	0.88
H22083206	8-32 x 11/32"	0.30	H23142008	1/4-20 x 7/16"	1.00
H22102407	10-24 x 3/8"	0.30	H23142808	1/4-28 x 7/16"	0.88
H22103207	10-32 x 3/8"	0.30	H23161810	5/16-18 x 1/2"	1.00
H22122408	12-24 x 7/16"	0.30	H23162410	5/16-24 x 1/2"	1.00
H22142008	1/4-20 x 7/16"	0.30	H23181611	3/8-16 x 9/16"	1.13
H22142808	1/4-28 x 7/16"	0.30	H23182411	3/8-24 x 9/16"	1.13
H22161810	5/16-18 x 1/2"	0.30	H23201412	7/16-14 x 5/8"	1.13
H22162410	5/16-24 x 1/2"	0.40	H23202012	7/16-20 x 5/8"	1.13
H22181611	3/8-16 x 9/16"	0.40	H23222015	1/2-20 x 3/4"	1.25
H22182411	3/8-24 x 9/16"	0.40	H23261818	5/8-18 x 15/16"	1.38
H22201412	7/16-14 x 5/8"	0.40			
H22202012	7/16-20 x 5/8"	0.40			
H22221315	1/2-13 x 3/4"	0.40			
H22222015	1/2-20 x 3/4"	0.40			
H22261118	5/8-11 x 15/16"	0.40			
H22261818	5/8-18 x 15/16"	0.40			
H22301021	3/4-10 x 1 1/16"	0.40			
H22301621	3/4-16 x 1 1/16"	0.40			



Acorn nuts, chrome			Cap nuts, chrome		
H25102407	10-24 x 3/8"	1.63	H26102407	10-24 x 3/8"	1.88
H25103207	10-32 x 3/8"	1.63	H26103207	10-32 x 3/8"	1.88
H25142008	1/4-20 x 7/16"	1.88	H26142008	1/4-20 x 7/16"	1.88
H25142408	1/4-24 x 7/16"	1.88	H26142408	1/4-24 x 7/16"	1.88
H25142808	1/4-28 x 7/16"	1.63	H26142808	1/4-28 x 7/16"	1.63
H25161810	5/16-18 x 1/2"	1.88	H26161810	5/16-18 x 1/2"	1.88
H25162410	5/16-24 x 1/2"	1.88	H26162410	5/16-24 x 1/2"	1.88
H25181611	3/8-16 x 9/16"	2.00	H26181611	3/8-16 x 9/16"	2.13
H25182411	3/8-24 x 9/16"	2.00	H26182411	3/8-24 x 9/16"	2.13
H25201414	7/16-14 x 11/16"	2.50	H26201414	7/16-14 x 11/16"	2.50
H25202014	7/16-20 x 11/16"	2.50	H26202014	7/16-20 x 11/16"	2.50
H25221315	1/2-13 x 3/4"	3.75	H26221315	1/2-13 x 3/4"	3.75
H25222015	1/2-20 x 3/4"	3.75	H26222015	1/2-20 x 3/4"	3.75
H25241217	9/16-12 x 7/8"	4.00	H26241217	9/16-12 x 7/8"	4.00
H25241817	9/16-18 x 7/8"	4.00	H26241817	9/16-18 x 7/8"	4.00
H25261118	5/8-11 x 15/16"	5.63	H26261118	5/8-11 x 15/16"	5.63
H25261125	5/8-11 x 1 1/4"	8.13	H26261818	5/8-18 x 15/16"	5.63
H25261818	5/8-18 x 15/16"	6.88			
H25261825	5/8-18 x 1 1/4"	9.63			
H25301622	3/4-16 x 1 1/8"	7.75			

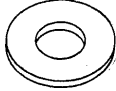
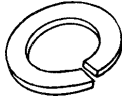

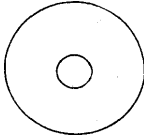
Standard Hardware

Standard flatwasher, zinc			Standard flatwasher, chrome			Flatwasher, stainless steel		
H40042002	4 x 5/16" x 1/32"	0.20	H41082802	8 x 7/16" x 1/32"	0.30	H45082402	8 x 3/8" x 1/32"	0.30
H40062403	6 x 3/8" x 3/64"	0.20	H41103202	10 x 1/2" x 1/32"	0.30	H45102803	10 x 7/16" x 3/64"	0.30
H40082804	8 x 7/16" x 1/16"	0.20	H41123604	12 x 9/16" x 1/16"	0.30	H45144004	1/4" x 5/8" x 1/16"	0.30
H40103203	10 x 1/2" x 3/64"	0.20	H41143603	1/4" x 9/16" x 3/64"	0.38	H45164404	5/16" x 11/16" x 1/16"	0.30
H40123604	12 x 9/16" x 1/16"	0.20	H41164004	5/16" x 5/8" x 1/16"	0.38	H45185204	3/8" x 13/16" x 1/16"	0.30
H40144004	1/4" x 5/8" x 1/16"	0.20	H41184804	3/8" x 3/4" x 1/16"	0.38	H45206004	7/16" x 15/16" x 1/16"	0.30
H40164404	5/16" x 11/16" x 1/16"	0.20	H41244806	7/16" x 3/4" x 3/32"	0.38	H45226804	1/2" x 1-1/16" x 1/16"	0.30
H40185204	3/8" x 13/16" x 1/16"	0.20				H45268404	5/8" x 1-5/16" x 1/16"	0.30
H40206005	7/16" x 15/16" x 5/64"	0.20						
H40226805	1/2" x 1-1/16" x 5/64"	0.20						
Standard lockwasher, zinc			Standard lockwasher, chrome			Lockwasher, stainless steel		
H50041202	4 x 3/16" x 1/32"	0.20	H53081803	8 x 9/32" x 3/64"	0.30	H55081802	8 x 9/32" x 1/32"	0.30
H50061602	6 x 1/4" x 1/32"	0.20	H53102003	10 x 5/16" x 3/64"	0.30	H55102003	10 x 5/16" x 3/64"	0.30
H50081803	8 x 9/32" x 3/64"	0.20	H53143004	1/4" x 15/32" x 1/16"	0.30	H55143004	1/4" x 15/32" x 1/16"	0.30
H50102103	10 x 21/64" x 3/64"	0.20	H53163605	5/16" x 9/16" x 5/64"	0.30	H55163605	5/16" x 9/16" x 5/64"	0.30
H50122404	12 x 3/8" x 1/16"	0.20	H53184306	3/8" x 43/64" x 3/32"	0.30	H55184406	3/8" x 11/16" x 3/32"	0.30
H50143104	1/4" x 31/64" x 1/16"	0.20	H53204807	7/16" x 3/4" x 7/64"	0.30	H55204807	7/16" x 3/4" x 7/64"	0.30
H50163605	5/16" x 9/16" x 5/64"	0.20	H53225508	1/2" x 55/64" x 1/8"	0.30	H55225408	1/2" x 27/32" x 1/8"	0.30
H50184307	3/8" x 43/64" x 7/64"	0.20	H53266710	5/8" x 1-3/64" x 5/32"	0.30	H55266709	5/8" x 1-3/64" x 9/64"	0.30
H50204908	7/16" x 49/64" x 1/8"	0.20						
H50225509	1/2" x 55/64" x 9/64"	0.20						
H50246008	9/16" x 15/16" x 1/8"	n.a.						
H50266710	5/8" x 1-3/64" x 5/32"	0.20						
H50308012	3/4" x 1-1/4" x 3/16"	0.20						
External lockwasher, zinc			Internal lockwasher, zinc					
H51040000	# 4	0.20	H52040000	# 4	0.20			
H51060000	# 6	0.20	H52060000	# 6	0.20			
H51080000	# 8	0.20	H52080000	# 8	0.20			
H51100000	#10	0.20	H52100000	#10	0.20			
H51120000	#12	0.20	H52120000	#12	0.20			
H51140000	1/4"	0.20	H52140000	1/4"	0.20			
H51160000	5/16"	0.20	H52160000	5/16"	0.20			
H51180000	3/8"	0.20	H52180000	3/8"	0.20			
H51200000	7/16"	0.20	H52200000	7/16"	0.20			
			H52220000	1/2"	0.20			
			H52260000	5/8"	0.20			
			H52280000	11/16"	0.20			
			H52300000	3/4"	0.20			
AN flatwasher (small O.D.), zinc			Hardened flatwasher, chrome			Fender washer (large O.D.), zinc		
H42062002	6 x 5/16" x 1/32"	0.20	H46143906	1/4" x 39/64" x 3/32"	0.80	H44106404	10 x 1" x 1/16"	0.20
H42082402	8 x 3/8" x 1/32"	0.20	H46164306	5/16" x 43/64" x 3/32"	0.80	H44146404	1/4" x 1" x 1/16"	0.20
H42102804	10 x 7/16" x 1/16"	0.20	H46185106	3/8" x 51/64" x 3/32"	0.80	H44169604	5/16" x 1-1/2" x 1/16"	0.20
H42143204	1/4" x 1/2" x 1/16"	0.20	H46205806	7/16" x 29/32" x 3/32"	0.80	H44189604	3/8" x 1-1/2" x 1/16"	0.20
H42163604	5/16" x 9/16" x 1/16"	0.20	H46226708	1/2" x 1-3/64" x 1/8"	0.80			
H42184004	3/8" x 5/8" x 1/16"	0.20	H46267308	5/8" x 1-9/64" x 1/8"	0.80			
H42204804	7/16" x 3/4" x 1/16"	0.20						
H42225604	1/2" x 7/8" x 1/16"	0.20						
H42267604	5/8" x 1-3/16" x 1/16"	0.20						
	