

'30-'36 VL Models

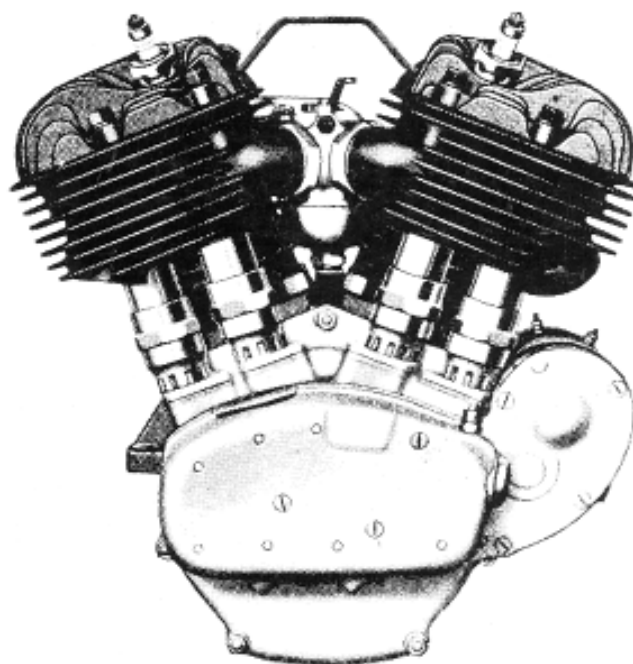

Jan Willem Boon

Meppelerweg 3
7963 RV Ruinen
The Netherlands

Phone: +31 (0)522-471177
E-mail: jw@jwboon.com
Web: www.jwboon.com

How to use this catalog:

Part number:
All numbers that begin with a letter (R, C) are reproduction parts, other numbers are original Harley parts (new old stock).

Price:
Prices are in Euro's. 
Prices include dutch sales-tax.
Sales-tax will be deducted on shipments outside the EU.
Dutch sales-tax is 21%, except books (9%).
"n.a." is "not available" (sold out)

Refers to letter in picture.
In this case you can choose between four part numbers.

A.	2326-38	Hex plug	'38-'51	park	n.a. *
"	R2326-38P	Hex plug	'38-'51	park	7.50 *
"	R2326-38	Hex plug	'38-'51	cad	7.50 *
"	R2326-38C	Hex plug	'38-'51	chrome	10.63 *
B.	C8115-1	Hex plug	'52-'73	cad	6.25 *
"	C8114-1	Hex plug	'52-'73	chrome	9.38 *

The little star * means the part was manufactured in the USA.
No star means not USA-made or we do not know. (we rely on information from our suppliers)

How to order:

You can order by phone, e-mail, or website form.

When ordering parts you need to give your name and address, and the list of part numbers you require.
The part numbers are the bold printed numbers in this catalog.

You must use part numbers from this catalog, do not use Harley "oem" part numbers.

Payment and shipping depend on the size of the order, and to which country it is shipped.

You can find the cost for most common shipments on the website.

Minimum order: € 125.00

Jan Willem Boon

Meppelerweg 3
7963 RV Ruinen
The Netherlands

Phone: +31 (0)522-471177 9.00-17.00 weekdays
E-mail: jw@jwboon.com
Web: www.jwboon.com

mailorder only



Info:

Pictures in this catalog are for illustration purpose only, do not use for technical reference.

Most older paper gaskets need to be soaked in water for 10 minutes to regain their original size.

The Harley-Davidson part numbers are for reference only.

For up-to-date information check our on-line database:
www.jwboon.com

About nuts:

Early 1940's and earlier nuts were mostly manufactured by H-D and were machined from stock. These nuts are clearly different than the later style nuts.



See the "Bolts and Nuts" section in the back of this catalog for a complete list

Hex bolt head markings:

'41 and earlier bolts were usually made by Harley and were not marked (plain head). War-time production saw the arrival of other suppliers, these could be marked "1035 cp" or "1038cp"



See the "Bolts and Nuts" section in the back of this catalog for a complete list

Manuals	2	Petrol & Oil Tank	26
Spare Parts Catalogs	2	Petrol & Oil Tank / Tool Box	27
Service Manuals	2	Tool Box Parts	27
Service Department Bulletins (Shop Dope)	2	Petrol & Oil Lines	28
"The Enthusiast"	3	Petrol Filter, '32-'36	28
Owner's Manuals / Riders Handbooks	3	Fender	29
Accessory Catalogs	3	Chainguard / Axle	30
Miscellaneous Books	4	Rear Axle Parts	30
Upper Engine Parts	7	Rear Brake	31
Stock Hardware Kit	7	Front Brake	32
Cylinder Head Gaskets	7	Electrical	34
Cylinder Head Bolts	7	Battery Box Parts	34
Cylinder Base	7	Wiring Kit	34
Spark Plugs	8	Switches / Horn	35
Valves	8	Relay	35
Valve Spring Covers	9	Horn Mounting Parts	35
Tappets	9	Headlamp and Parts '35-'36	36
Pistons	10	Taillight Lenses	36
Lower Engine Parts	11	Accessories	37
Connecting Rod Bearing	11	Ride Control Parts '33-'36	38
Engine Shafts	11	Roller Bearing Roller Guide	38
Crankcase Bearings	12	Tools	39
Motor Mounting, lower	12	Heli-Coil® / Special size Taps & Dies	40
Top Motor Mount	12	Taps and Dies, Special Sizes	40
Crankcase Bolts and Studs	12	Taps, Dies, Drills	41
Timing Hole Plugs	13	Drills	41
Exhaust systems	14	Screws, Bolts, Nuts	42
Carburetor Manifold Parts	14	Round Head Screws	42
Generator	16	Fillister Head Screws	42
Timer / Spark Coil	18	Oval Countersunk Head Screws	42
Chains & Sprockets	19	Hex Head Bolts	43
Starter Pedal	19	Nuts	44
Shifter Parts	20	Washers	45
Clutch Parts	20	Lockwashers	46
Fork Parts	21	Steel Balls	46
Steering Damper	22	Rivets	46
Rear Chain Adjusters	22	Special lockwashers	46
Rear Stand Parts	22	Grease Fittings	46
Footboards	22	Cotter pins	46
Solo Seat	23	Standard Hardware	47
Seat Post	24		
Handlebar Parts	25		

Manuals

€ prices in euro

Spare Parts Catalogs

Essential information for restoring your Harley-Davidson.
Books 500 to 503 have photos, later books have exploded views.

L500	'13-'21 Twins	95 p.	16.00 ☼
L501A	'22-'28 all except opposed Twin	90 p.	12.00
L502	'28-'32 all models	105 p.	15.00
L516	'26-'39 all models	175 p.	20.00 ☼
L503	'30-'40 Twins	150 p.	22.00
L504	'37-'49 Big Twins	148 p.	15.00
L505	'40-'50 750cc civilian and Servi-car	124 p.	15.00
L541	'40-'43 WLA military models	124 p.	15.00
L506	'49-'57 Twins incl. Servi-car	156 p.	n.a.
L508	'58-'73 Servi-car	127 p.	16.00 ☼
L507A	'54-'65 KH, XLH, XLCH	106 p.	18.00 ☼
99451-80	'79-'80 Sportster	104 p.	45.00 ☼
L498	'48-'55 Lightweight models	52 p.	16.00 ☼
L499	'56-'65 Lightweight models	62 p.	16.00 ☼
L509A	'58-'68 Panhead/Shovel	149 p.	15.00 ☼
99455-80	'71-'80 FX	233 p.	45.00 ☼
99438-80	1980 FLT	104 p.	45.00 ☼
99438-82	'80-'82 FLT	141 p.	45.00 ☼



Service Manuals

L525	1928 Schebler Carburetor Manual	45 p.	16.00
L543	'41-'45 WLA Maintenance Manual	206 p.	16.00
This manual contains assembly, maintenance, organisational and test procedures for WLA or other 750cc models. Army #TM 9-879, use with overhaul manual L544 .			
L544	'41-'45 WLA Overhaul Manual	216 p.	16.00
Best manual available for all 750cc models '41-up. Army #TM 9-1879, use with L543 maintenance manual.			
L546	1942 Uncrating and Assembly	21 p.	7.50
WLA, full page photos.			
L547	1943 Motorcycle mechanics book	134 p.	20.00
WLA and XA. "The Armored School", Fort Knox.			
L548	WLC Service and operators manual	80 p.	14.00
L521	Service Manual '40-'47 Big Twins		15.00 ☼
99485-84	Sidecar Manual '79-'84 CLE/TLE		30.00 ☼
99483-80	Service Manual 1980 FLT		45.00 ☼
99483-81	Service Manual '80-'81 FLT		45.00 ☼
99498-77	Service Manual '77-'78 XLCR		85.00 ☼
L536	Service Manual '59-'66 Lightweights		17.00 ☼

Service Department Bulletins (Shop Dope)

Collections of bulletins the factory sent to the dealers.

L530	Volume I	All models	'?- '29	18.00 ☼
L531	Volume II	All models	'30-'40	18.00 ☼
L532	Volume III	All models	'41-'56	18.00 ☼
L533	Volume IV	All models	'56-'69	27.00 ☼



prices
in euro €



Manuals

Owner's Manuals / Riders Handbooks

Includes wiring diagram, lubricating instructions, adjustments, etc.

L561	1926	Singles	36 p.	n.a.
L562	1929	'20's Pocket-valves	63 p.	9.00
(includes supplement covering '15-'29 models)				
L563	1935	750cc (R models)	40 p.	9.00 ☉
L587	1936	VL models	40 p.	n.a.
L545	'43	WLC, also WLA and WL	36 p.	9.00
L565C	1950	Panhead	54 p.	11.00 ☉
L565A	1955	Panhead	68 p.	11.00 ☉
L565B	'58-'64	Panhead	60 p.	11.00 ☉
99460-76	1976	FL, FX	70 p.	15.00 ☉
99460-77	1977	FL, FX	72 p.	15.00 ☉
99460-78	1978	FL, FX	76 p.	15.00 ☉
99460-78E	1978½	FL, FX	80 p.	15.00 ☉
99460-79	1979	FL, FX	80 p.	15.00 ☉
99466-72	1972	Sportster	60 p.	20.00 ☉
99466-74	1974	Sportster	60 p.	17.00 ☉
99466-75	1975	Sportster	60 p.	15.00 ☉
99466-76	1976	Sportster	60 p.	15.00 ☉
99466-77	1977	Sportster	64 p.	15.00 ☉
99468-77	1977	XLCR	56 p.	20.00 ☉
99466-78	1978	Sportster	64 p.	15.00 ☉
99465-81	1981	FLT	118 p.	20.00 ☉

Accessory Catalogs

Showing all accessories available that year, including buddy-seats, saddlebags mirrors, spotlights, wind screens, lap aprons, air cleaners, clothing, hats, badges, police accessories, tools, special workshop tools, goggles, etc, etc.

L550	1918-1919	94 p.	16.00
L552	1934	32 p.	12.00 ☉
L553	1936	32 p.	9.00
L554	1941	72 p.	15.00 ☉
L555	1947	69 p.	15.00
L556	1957	60 p.	15.00 ☉
L557	1960	30 p.	15.00 ☉

"The Enthusiast"

Every year, usually late summer, the new models were announced in "The Enthusiast". Now you have an opportunity to buy the issue that announced your Harley, 1924 to 1958, barring World War II years. These Enthusiasts are also fascinating period magazines often with articles, letters and pictures from all over the world, technical hints, race reports, police department news, etc.

Quality reprints, 21½ x 14 cm., about 24 pages.

L151	1924 models	L168	1941 models
L152	1925 models	L169	1947 models
L153	1926 models	L170	1948 models
L154	1927 models	L171	not available
L155	1928 models	L172	1950 models
L156	1929 models	L173	1951 models
L157	1930 models	L174	1952 models
L158	1931 models	L175	1953 models
L159	1932 models	L176	1954 models
L160	1933 models	L177	1955 models
L161	1934 models	L178	1956 models
L162	1935 models	L179	1957 models
L163	not available	L180	not available
L164	1937 models		
L165	1938 models		
L166	1939 models		
L167	1940 models		

Military Editions

L181	October 1942
L182	not available



	1 copy	9.00 ☉
L150	6 copies	32.00 ☉
L149	12 copies	60.00 ☉

L590	1916 Sales Brochure	24 p.	n.a.
L591	1917 Sales Brochure	5 p.	3.00
L534	1950 WR/WRTT sales brochure	4 p.	7.00

Miscellaneous Books

“At The Creation”

by Herbert Wagner

For good reason the origin period of the Harley-Davidson motorcycle has been called an “era of mystery”. Not only were Harley-Davidson’s origins poorly recorded, but the company’s beginnings were further obscured by later confused and contradictory claims that developed into myths. In this work, Herbert Wagner examines several long-standing puzzles and unanswered questions. This book is the definitive account of the beginnings of the only surviving American motorcycle brand.

L686 At the creation 228 pages 45.00

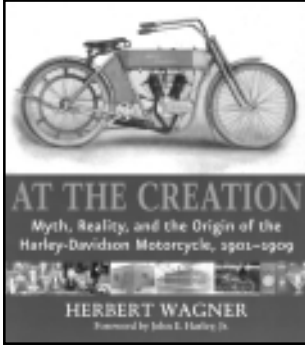

“Cross Index of Harley-Davidson Part Numbers”

Parts catalogs from 1950 and earlier use the “old” part numbers, 1951 and later parts catalogs use the “new” parts numbers. This manual is a cross-index between the old and new numbers.

L593 Cross index of H-D part numbers 53 pages 18.00

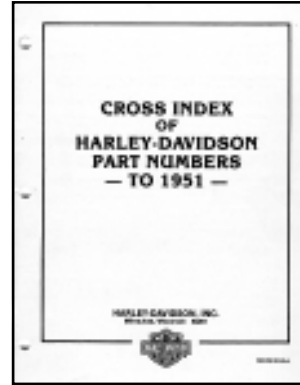

“Harley-Davidson Flatheads”

by Jerry Hatfield

One of the most versatile motorcycles ever built, the Flathead anchors the Harley-Davidson lineage. Flathead engines powered The Motor Company’s success in the 1930s when a fourth of all workers were laid off, and were the Army’s “weapon of choice” during World War II. Author Jerry Hatfield chronicles 55 years of the type’s engineering, military service, racing adventures, and sales success. Restorers will find this book indispensable, but any H-D enthusiast will enjoy this colorful fact-filled account of The Motor Company’s jack-of-all-trades, the Flathead.

L645 Flatheads 128 pages 26.00

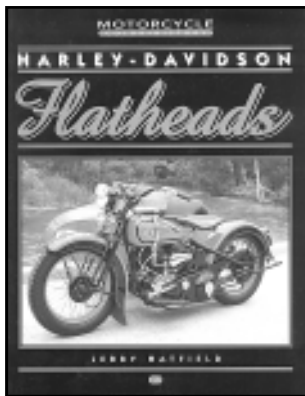

“The Big Book Of Harley-Davidson”

by Thomas C. Bolfert 1996 edition

Beautiful hard cover, full color, large size book, 10" x 12½" / 25 x 32 cm, 300 pages

Follow the trail of this American success story as it winds through history, decade by decade, influenced by wars, depressions, and severe competition from domestic and foreign sources, only to emerge in the 1990’s stronger and more popular than ever. Told in an easy narrative style, and illustrated by over a thousand colorful photos dating back to the turn of the century, the story of Harley-Davidson is fitted against a historical timeline that helps put its long past into the proper perspective of the prevailing times.

L619 Big Book of H-D 300 pages 70.00



“Growing Up Harley-Davidson”

by Jean Davidson

This memoir of the Harley-Davidson motorcycling dynasty contains rare photos from the family album, as well as the inside scoop on the behind-the-boardroom-door politics and corporate battles, adding new tales to fuel the myth behind one of the world’s great pop culture icons. All copies autographed by Jean Davidson.

L687 Growing up H-D 270 pages hard cover 20.00

L688 Growing up H-D limited edition paperback 25.00

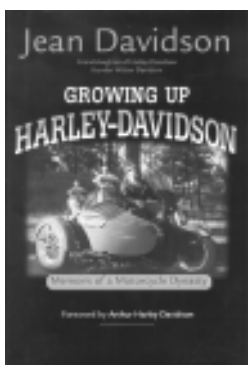

“H-D Classics 1903-1965”

-Illustrated Buyer’s Guide-
by Jerry Hatfield

Harley-Davidson was synonymous with raw power and speed in the early days of motorcycling. Those tremendous machines are chronicled here, from the early singles to the Panhead Big Twins and Sportsters. Each bike is covered year by year, with ratings for collectibility, smoothness of ride, passenger accommodations, reliability, and parts and service availability. This formidable group of data is supplanted with the author’s riding impressions, which put you in the driver’s seat of dozens of collectible Harley-Davidson motorcycles. With this comprehensive book, you’ll be well-equipped to select the year and model perfect for your needs, whether it is a 1914 Twin with sidecar, 1941 WLD, 1936 Model EL Knucklehead, or 1957 Sportster.

L639 Buyer’s Guide 1903-1965 192 pages 20.00

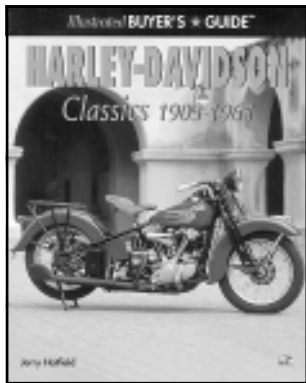

“Motorcycle Memorabilia”

by Roger Pribbenow.

Motorcycle Memorabilia is an enjoyable look at the sport of motorcycling from its beginning around 1900 to the mid-1960’s. Photographed in full color are a great variety of items illustrating the scope of memorabilia collecting and items available to the collector. From catalogs and brochures to motorcycle toys and clothing, manufacturers pins and oil containers, you’ll find it all here. Covers all American-made motorcycles.

L647 Motorcycle Memorabilia 78 pages 18.00



“Classic H-D 1903-1941”

by Herbert Wagner

Delving into the depths of Harley-Davidson history, author Herbert Wagner brings readers many new discoveries on the evolution of the Harley-Davidson Motorcycle. From the turn-of-the-century single-cylinder prototype to the 1941 74 OHV Big Twin Knucklehead, *Classic Harley-Davidson 1903-1941* captures the dream of Bill Harley and the Davidson brothers. Over 80 color photographs help illustrate this amazing story, depicting such models as: 1903 to 1905 Singles - Early V-twins, World War I military models, JDH and JH models (two-cam)- 21" and 45" OHV models - VL and VLH Flatheads - EL and FL Knuckleheads

L644 Classic H-D 1903-1941 96 pages 18.00

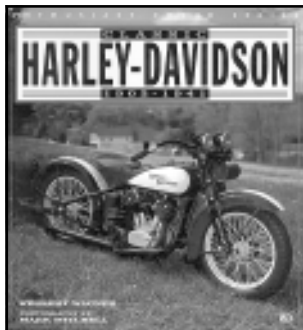

“Harley-Davidson in the 1960s”

by Allan Girdler & Jeff Hackett.

“Harley-Davidson in the 1960s” chronicles The Motor Company’s efforts to survive the Asian onslaught, a struggle that transforms Harley-Davidson-a family run business concern-into a division of AMF. In the process it tells the story of some of the most exciting motorcycles of all time. Covers all models; Duo-Glide, Early-Shovel, Sportster, KR-TT racer, Sprint, Topper scooter, etc.

L655 H-D in the 1960’s 95 pages 16.50

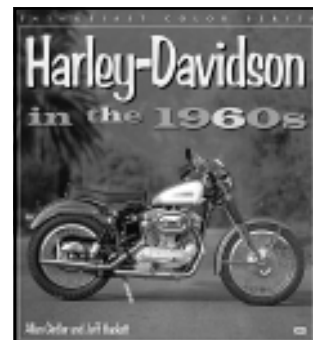

"The H-D Motor Co. - Archive Collection"

by Randy Leffingwell and Darwin Holmstrom
 Since its earliest days, the Harley-Davidson Motor Co. has saved examples of nearly every motorcycle it has ever built. In over 600 studio portraits, Harley-Davidson and master photographer Randy Leffingwell present this historically significant collection of production models, racing bikes, and one-of-a-kind prototypes.

L679 Archive Collection 408 pages 26.00



"This Old Harley"

by Michael Dregni
This Old Harley captures just what it is about Harleys that makes them so popular. This anthology is a tribute not only to this legendary piece of American automotive machinery, but also to the stories, histories, and lifestyles behind its rise as the world's most popular motorcycle.

L673 This old Harley 160 pages 26.00

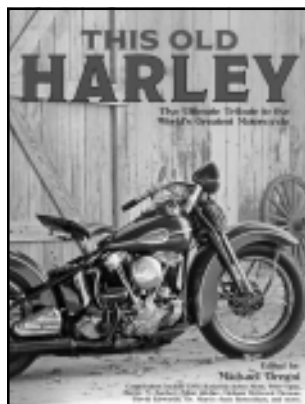

"Harley-Davidson Family Memories"

by Jean Davidson, Jon Davidson Oeflein

L676 Family Memories 168 pages hard cover 33.00



"Harley and the Davidsons"

by Pete Barnes
 A short history of the Harley-Davidson company, written for young readers.

L680 Harley and the Davidsons 106 pages 13.50

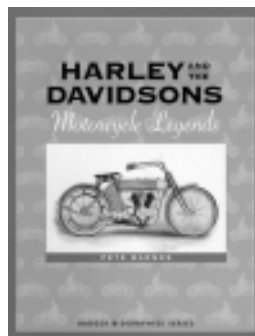

"Museum Masterpieces"

by Dain Gingerelli
 - 51 bikes featured
 - over 250 color photos
 - performance and production specs
 - historical facts and trivia about each bike

L675 240 pages 22.00

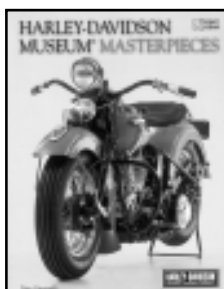

"The Harley in the Barn"

by Tom Cotter
 The Harley in the barn offers 40-plus tales of lost Nortons, hidden Harleys, dormant Indians, and busted BSA's, all squirreled away from prying eyes but found by lucky collectors just like you.

L683 256 pages hard cover 24.00

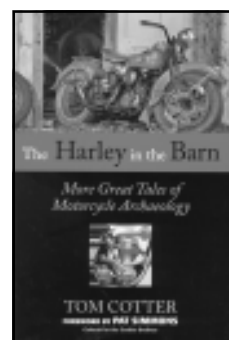

"kids Books"

by Jean Davidson

L677 "My daddy makes the best..." (autographed) 24.00
L678 "Riding back in time" (autographed) 24.00
L684 Coloring book 7.00
L685 Activity book 7.00

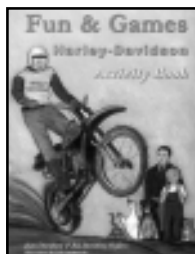

"The Encyclopedia of the Harley-Davidson"

by Peter Henshaw & Ian Kerr
 The world's most famous motorcycle manufacturer is celebrated in this comprehensive guide, from its humble beginnings to the successful company it is today.

L681 The encyclopedia of H-D 442 pages hard cover 23.00

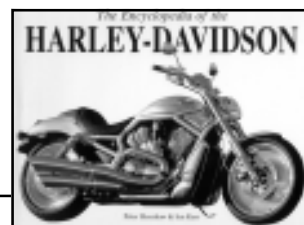

Stock Hardware Kit

This kit includes all the stock bolts, nuts, screws and washers to rebuild the motor. Cad plated and parkerized as original.

C8323CAD	Stock hardware kit	early '30	cad/park	325.00	⊕
C8318CAD	Stock hardware kit	late '30-'36	cad/park	306.25	⊕



Cylinder Head Gaskets

R11-30.5pack	Gaskets (5)	'30-'35	black	32.00	⊕
R11-30	Gasket	.050"	'30-'35 blue paper	14.00	⊕
R11-36Acop	Gasket, 9 bolt head	'36-only	copper	6.00	
R11-36Ate	Gasket, 9 bolt head	'36-only	blue teflon	8.00	⊕

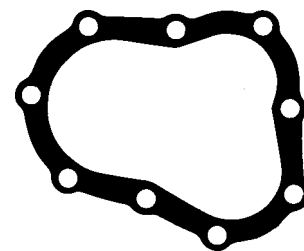

Cylinder Head Bolts

- Early 1930 only bolt has 7/16"-20 thread.

- Late 1930-1936 bolts have 7/16"-16 thread.

14-30	Head bolt	early 1930 only	park	10.00	⊕
R14-30BP	Head bolt	late '30-'36	park	6.25	⊕
R14-30B	Head bolt	late '30-'36	cad	6.25	⊕
R14-30BC	Head bolt	late '30-'36	chrome	7.50	⊕
R0232P	Washer, head bolt		park	0.88	⊕
O232	Washer, head bolt		cad	1.50	⊕
R0232	Washer, head bolt		cad	0.94	⊕
R0232C	Washer, head bolt		chrome	1.25	⊕
14-30S	Oversize bolt	1/2"-13	park	11.00	⊕

Cylinder Headbolt Kits

Kit includes 18 bolts with washers, 7/16"-20 thread.

C3260-36	Headbolt kit	early '30	park	118.75	⊕
-----------------	--------------	-----------	------	--------	---



Kits include 18 bolts with washers, 7/16"-16 thread.

C9728-36	Headbolt kit	late '30-'36	park	112.50	⊕
C7712-36	Headbolt kit	late '30-'36	cad	112.50	⊕
C8218-36	Headbolt kit	late '30-'36	chrome	137.50	⊕

Heli-Coil® thread repair

Special 7/16"-16 thread for cylinder repair.

Heli-Coil thread repair kit comes complete with 6 inserts, tap, installation tool and instructions. Order drill separately.

H5540-7	Heli-Coil repair kit	7/16"-16	n.a.	⊕
HR389-7-2	Set inserts only (6)		24.00	⊕
M6129D	Drill, use with kit	29/64"	n.a.	

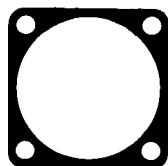
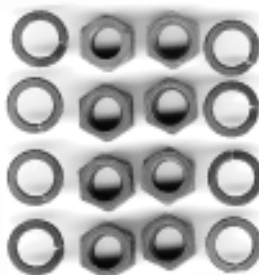
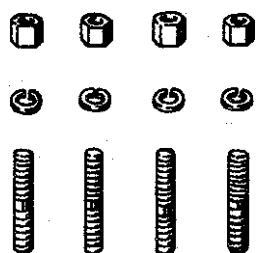

Stock



Acorn



Cap

Cylinder Base

R29-30	Stud, cylinder base		4.81	⊕
C8856-8	Set cylinder base studs		37.50	⊕
O134	Nut, cylinder base	park	2.00	⊕
R0134P	Nut, cylinder base	park	1.69	⊕
R0134	Nut, cylinder base	cad	1.81	⊕
R0134C	Nut, cylinder base	chrome	3.13	⊕
R0134NI	Nut, cylinder base	Nickle	2.50	⊕
R0265P	Lockwasher	park	0.69	⊕
R0265	Lockwasher	zinc	0.75	⊕
R0265C	Lockwasher	chrome	0.94	⊕

Cylinder Base Nut Kits

Kits include 8 nuts with lockwashers

C9623-16	Stock nuts	park	17.50	⊕
C8105-16	Stock nuts	cad	17.50	⊕
C8104-16	Stock nuts	chrome	25.00	⊕
C7017-16	Acorn nuts	chrome	25.00	⊕
C8437-16	Cap nuts	chrome	26.25	⊕
C9716-8	Lockwashers only	park	5.38	⊕
C8171-8	Lockwashers only	cad	5.63	⊕
C9715-8	Lockwashers only	chrome	6.63	⊕

R46-21	Gasket, cylinder base		2.50	⊕
R46-21-X	Gasket, cylinder base	rubber metal base	21.00	⊕

Upper Engine Parts

Spark Plugs

R37-09D14	Spark plug Champion (# 3 heat range)	4.50
R37-09A-7	Spark plug NGK (colder # 4 heat range)	3.50
40-08	Gasket, spark plug	1.50 ☼



R11929-40 Spark plug wrench n.a.
(This wrench is for use with original style spark plugs, 1-1/8" wrench size, does not fit above plugs)



Heli-Coil® thread repair

To repair stripped spark plug hole threads 18mm-1.50 thread
Kit includes piloted tap, installation tool and 24 inserts.

H5523-18	Thread repair kit	n.a. ☼
HR514-6	Set insert only (6)	24.00 ☼



Valves

A.	R163-30	Valve, inlet		20.00
"	R163-30N	Valve, inlet	black nitrited	22.00
"	R165-30	Valve, exhaust		n.a.
"	R165-30N	Valve, exhaust	black nitrited	22.00
B.	R166-30	Valve guide	O.D. 0.596"	23.50 ☼
"	R166-30.1	Valve guide	oversize +.001"	n.a. ☼
"	R166-30.2	Valve guide	oversize +.002"	27.00 ☼
"	R166-30C.2	Set of 4	oversize +.002"	44.00
	170-30	Valve collar, early 1930 only		4.00 ☼
D.	R168-30B	Valve spring	late '30-'36	6.50
E.	R170-30A	Collar	late '30-'36	6.50
F.	R171-30	Collar	late '30-'36	6.50
G.	172-30	Keys, valve (2)		2.50 ☼
"	172-30.10pack	Keys, valve collar (20)		18.00 ☼

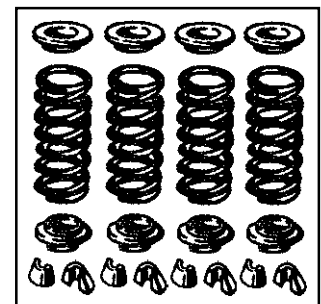
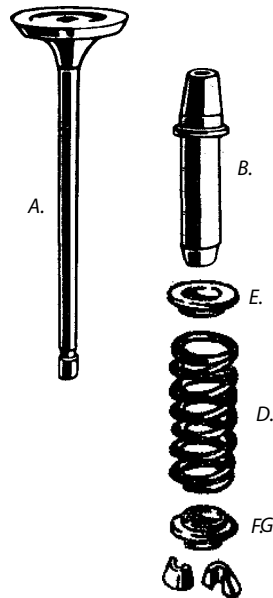

15-0016

15-0016	Valve spring kit	late '30-'36	70.00
	Includes springs, collars & keepers		

Valve Guide Drivers

- 3/8" driver can be used for 1200cc Flathead, Knuckle, Pan, Shovel etc.
- Set also includes drivers for 750cc and Sportster.

R1001-1	Driver	.370" (3/8")	35.00 ☼
R1001	Set of three sizes		65.00 ☼



Valve Spring Covers '30-'36

C2885-24	Set valve spring covers	cad	218.75 ☼
C3091-24	Set valve spring covers	chrome	285.00 ☼
R11806-30	Wrench, upper	'37-'38	27.50 ☼
R11806-30A	Wrench, lower	'37-'38	27.50 ☼

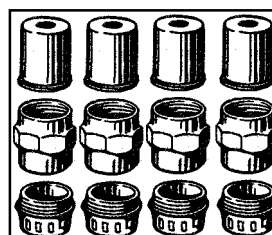

Tappets

Tappets with "lightning" holes, without screw/nut '29-'73.

JIMS	B.	R200-29jims	Tappet	Std.	O.D. 0.730"	85.00	⊕
	"	R200-29.005jims		Oversize	+0.005"	n.a.	⊕
	D.	R208-29	Tappet roller kit			10.00	⊕
	"	R208-29set	Set tappet roller kits (4)			34.00	⊕
	E.	R214-29	Pin only, tappet roller			0.60	⊕
	F.	R221-40	Screw, tappet		9/32"-32	6.88	⊕
JIMS	"	R221-40.4pack	Tappet screws		9/32"-32	25.00	⊕
		R221-40A	Tappet screw & nut			9.06	⊕
	G.	223-38	Nut, tappet screw		9/32"-32	3.50	⊕
	"	R223-38	Nut, tappet screw		9/32"-32	1.50	⊕
JIMS	"	R223-38.4pack	Nuts, tappet screw		9/32"-32	8.00	⊕
	H.	237-30	Gasket, tappet guide			1.00	⊕

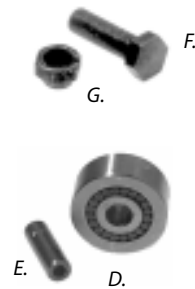
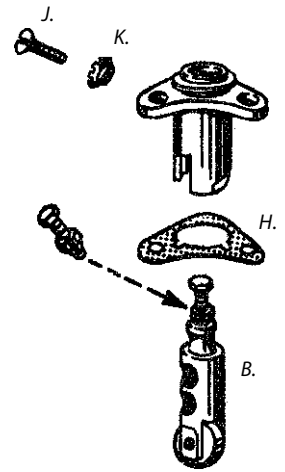

Tappet Guide Screws

1/4"-24 thread

J.	R057P	Screw, slotted head	park	1.56	⊕
"	R057	Screw, slotted head	cad	1.56	⊕
"	R057C	Screw, slotted head	chrome	2.19	⊕
"	R057NI	Screw, slotted head	Nickle	1.75	⊕
K.	R0365P	Lockwasher	park	0.38	⊕
"	R0365	Lockwasher	zinc	0.25	⊕

Kits includes 8 screws with lockwashers

C9622-16	Kit, slotted head screws	park	14.38	⊕
C8103-16	Kit, slotted head screws	cad	15.00	⊕
C8102-16	Kit, slotted head screws	chrome	18.75	⊕
C7131-8	Kit, acorn head screws	chrome	30.00	⊕
C8447-8	Kit, cap head screws	chrome	30.63	⊕
C8760-16	Kit, Allen head screws	chrome	19.38	⊕

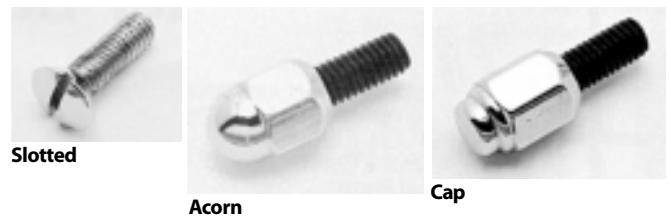

M1421T	Tap 1/4"-24 for tappet guide screws	7.00	⊕
---------------	-------------------------------------	------	---

Heli-Coil® thread repair

Repair kit includes 12 inserts, tap and installation tool, order drill seperately.

H5540-4	Heli-coil thread repair kit	1/4"-24	125.00	⊕
HR389-4	Set Heli-coil inserts only	(12)	25.00	⊕
M6117D	Drill 17/64", use with kit		5.00	⊕



Pistons

Pistons

30-36 74" (1200cc)

Pistons are sold each, including:

- 1/16" compression rings, 3/16" oil ring
- piston pin with late style pin keepers (22582-52)
(install with tool **R96780-58A**)

R256-30B	Piston	standard	3.437"	87,27 mm	n.a.
R256-30D	Piston	oversize	+0.010"	87,52 mm	n.a.
R256-30E	Piston	oversize	+0.020"	87,77 mm	n.a.
R256-30F	Piston	oversize	+0.030"	88,02 mm	n.a.
R256-30G	Piston	oversize	+0.040"	88,26 mm	n.a.
R256-30H	Piston	oversize	+0.050"	88,53 mm	110.00
R256-30JA	Piston	oversize	+0.060"	88,79 mm	110.00
R256-30KA	Piston	oversize	+0.070"	89,05 mm	110.00
R256-30MA	Piston	oversize	+0.080"	89,30 mm	110.00
R256-30Q	Piston	oversize	+0.090"	89,55 mm	110.00



Piston Ring Sets

Set is for two pistons (6 rings)

- 1/16" compression rings, 3/16" oil rings

R22325-55	Ring set	standard		18.00
R22327-55	Ring set	oversize	+0.010"	18.00
R22328-55	Ring set	oversize	+0.020"	18.00
R22329-55	Ring set	oversize	+0.030"	18.00
R22330-55	Ring set	oversize	+0.040"	18.00
R22331-55	Ring set	oversize	+0.050"	18.00
R22332-55B	Ring set	oversize	+0.060"	17.00
R22335-78A	Ring set	oversize	+0.070"	17.00
R22336-78A	Ring set	oversize	+0.080"	17.00
R22336-78AP090	Ring set	oversize	+0.090"	17.00
R22336-78AP100	Ring set	oversize	+0.100"	17.00

280-32 Lock ring, piston pin split ring type 5.00 ☼

R280-32 Lock ring, piston pin split ring type 2.50

This type lock ring is used on original pistons, install. tool **R96780-32A**

R22582-52 Lock ring, piston pin expanding ring type 0.80

These lock rings are used with above pistons, install. tool **R96780-58A**

R295-36 Bushing, piston pin 0.896" O.D. 4.00

R295-36B Bushing, piston pin 0.902" O.D. n.a.

R295-36C Bushing, piston pin 0.907" O.D. 3.50

R294-36A Bushing, piston pin 1.006" O.D. 6.50 ☼

R294-36B Bushing, piston pin 1.008" O.D. 13.00 ☼

R294-36C Bushing, piston pin 1.011" O.D. 13.00 ☼

Piston Tools

R96780-32A Piston pin lock ring tool, for 280-32 74.50 ☼

R96780-58A Piston pin lock ring tool, for 22582-52 190.00 ☼

R95970-32C Piston pin bushing tool 185.00 ☼

Use to replace bushings without removing rods



R96780-32A



R95970-32C



R1235

R1236 Piston ring compressor set 132.50 ☼

Supplied with 6 bands ranging from 2-3/16" to 4-3/8" (does not fit 750cc models). Fine tooth ratcheting motion to compress bands in small increments for accurate compression. (will not break or damage rings)

R1235 Piston ring expander tool 38.50 ☼

Remove and install rings without fear of breakage. Smooth gripping edges firmly hold rings to eliminate possible ring damage. Expands rings gently to install in grooves.



R1236

Connecting Rod Bearing

CRR-KZK	Set of rod races (3) (Timken bearing steel)		180.00 ☺
305-15.12pack	Roller, standard	0.2498" x .726"	17.50 ☺
R305-15	Roller, standard	0.2498" x .726"	1.00 ☺
R305-15D	Roller, oversize	+0.0002"	0.60 ☺
R305-15F	Roller, oversize	+0.0004"	0.60 ☺
R305-15H	Roller, oversize	+0.0006"	0.60 ☺
R305-15KA	Roller, oversize	+0.0008"	0.60 ☺
R305-15MA	Roller, oversize	+0.0010"	0.60 ☺
R304-15	Roller, standard	0.2498" x .360"	n.a.
R304-15D	Roller, oversize	+0.0002"	0.60
R304-15F	Roller, oversize	+0.0004"	0.60
304-15H	Roller, oversize	+0.0006"	1.00 ☺
R304-15H	Roller, oversize	+0.0006"	0.60
304-15KA	Roller, oversize	+0.0008"	1.00 ☺
R304-15KA	Roller, oversize	+0.0008"	0.60
304-15MA	Roller, oversize	+0.0010"	n.a.

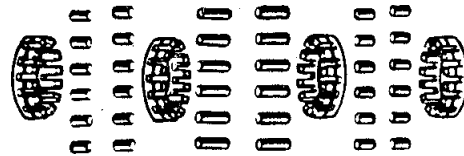

Rod Bearing Tools

R1003	Rod race removal & installation tool		285.00 ☺
--------------	--------------------------------------	--	----------

Kit includes collars for use on all Big Twin, 750cc and Sportster rods.

R11944-X	Rod lapping arbor	1-1/2"	357.50 ☺
R96740-36-4	Replacement lap head	1-1/2"	180.00 ☺
R96740-36	Rod lapping set		537.50 ☺

Includes 1-1/2" & 1-5/8" lap to lap all connecting rod races from 1915 and later.

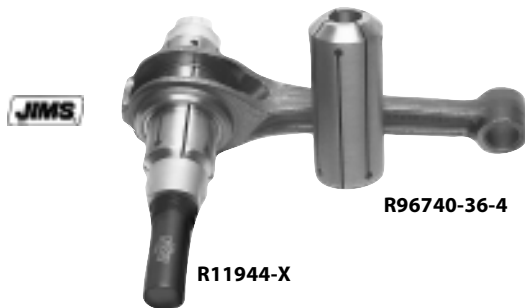
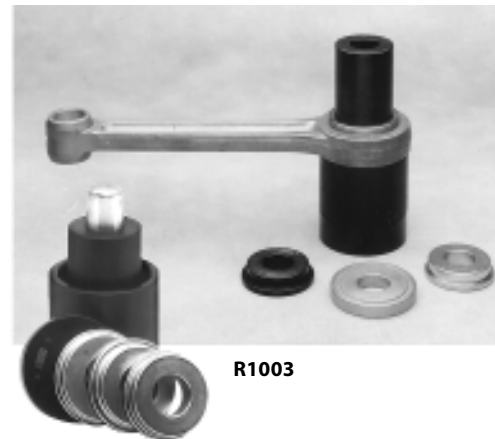

Engine Shafts

R348-15	Crank pin (Jims)		165.00 ☺
R348-30	Crank pin (Eastern)		95.00 ☺
R352-30	Sprocket shaft (Jims)		100.00 ☺
R355-30	Gear shaft, includes pinion nut		145.00 ☺
R365-15	Nut, crank pin		11.56 ☺
R364-30	Nut, sprocket and gear shaft		8.13 ☺
1650-18	Key, crank pin		2.00 ☺
R1650-18	Key, crank pin		0.40
R361-12	Key, sprocket & gear shaft		2.75 ☺
R030Z	Screw, shaft nut lockwashers		0.30 ☺
R358-17A	Set of flywheel thrust collars (11 sizes) (.060" to .110" except .094")		21.50 ☺
372-21	Washer, flywheelStd. .055" (1,39 mm) '30-'35		10.00 ☺
R372-21	Washer, flywheelStd. .055" (1,39 mm) '30-'35		7.00 ☺
R372-21B	Washer, flywheel O.S. .060" (1,52 mm) '30-'35		8.50 ☺
R372-21C	Washer, flywheel O.S. .067" (1,70 mm) '30-'35		9.00 ☺
R11967-38	End play gauge		45.00 ☺

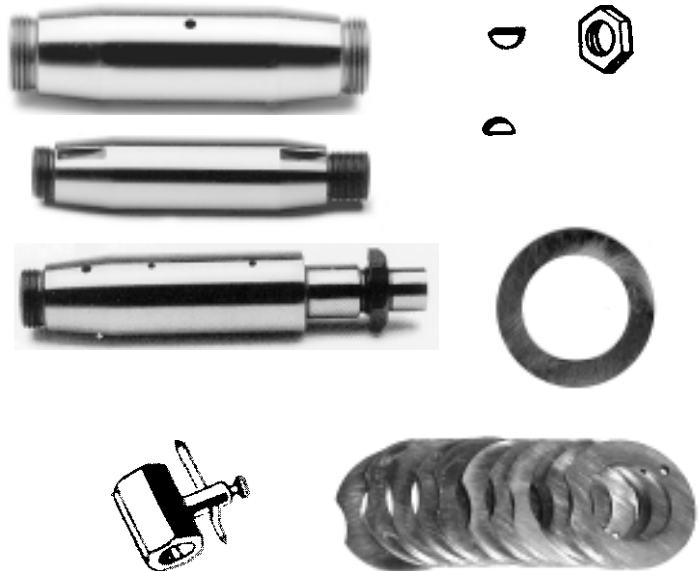

Lower Engine Parts

Crankcase Bearings

	R413-30	Right crankcase bushing		43.00	✚
	R416-30	Left bearing race std. O.D. 2.002"		70.00	✚
	R416-30B	Left bearing race oversize +.002"		71.00	✚
	R416-30C	Left bearing race oversize +.005"		72.00	✚
	R416-30D	Left bearing race oversize +.010"		73.00	✚
	417-30	Retainer, left bearing roller		n.a.	✚
L.	R2289-25	Roller, standard 0.2498" x .490"		0.50	✚
"	R9219	Roller, oversize +.0001"		0.50	✚
"	R2289-25D	Roller, oversize +.0002"		0.50	✚
"	R9218	Roller, oversize +.0003"		0.50	✚
"	R2289-25F	Roller, oversize +.0004"		0.50	✚
"	R9217	Roller, oversize +.0005"		0.50	✚
"	R2289-25H	Roller, oversize +.0006"		0.50	✚
"	R2289-25KA	Roller, oversize +.0008"		0.50	✚
"	R2289-25MA	Roller, oversize +.0010"		0.50	✚
"	R2289-25MA2	Roller, oversize +.0020"		0.50	✚



R413-30



R416-30

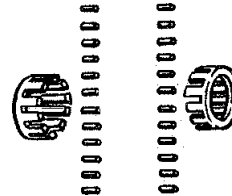

Bearing rollers also available in 100-packs

Motor Mounting, lower

	R437-26PS	Bolt plain head	park	6.25	✚
	R437-26	Bolt "1035 cp"	cad	6.25	✚
	R437-26C	Bolt	chrome	7.50	✚
	R0224P	Washer	park	0.63	✚
	R0224	Washer	cad	0.63	✚
	R0224C	Washer	chrome	0.88	✚
	R0224NI	Washer	Nickle	0.70	✚
	R0128P	Castle nut	park	2.00	✚
	R0128	Castle nut	cad	2.13	✚
	R0128C	Castle nut	chrome	2.31	✚
	R0128NI	Castle nut	Nickle	2.00	✚
	R0291P	Cotter pin	park	0.19	
	R0291	Cotter pin	zinc	0.15	

Motor Mount Kits, lower

Complete kits include bolts, nuts, washers, cotter pins

C3034-16	Kit	plain heads	park	39.38	✚
C8825-16	Kit	"1035 cp"	cad	40.63	✚
C9625-16	Kit		chrome	45.00	✚

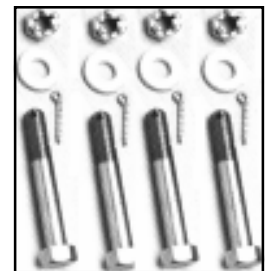

COLONY

Top Motor Mount

Mounts cylinder head bracket to frame

	2807-30	Bolt	park	5.00	✚
	2641-30	Nut	park	2.00	✚
	R0231P	Washer	park	1.25	✚
	R0234	Shim .015"		0.75	✚

Top Motor Mount Kits

Include bolt, nut, washer, lockwasher and shims.

C3035-5	Mounting kit	park	11.25	✚
C9780-5	Mounting kit	cad	11.25	✚
C9779-5	Mounting kit	chrome	15.00	✚



COLONY

Crankcase Bolts and Studs

	R444-30P	Bolt, crankcase	park	4.38	✚
	R444-30	Bolt, crankcase	cad	4.38	✚
	R444-30C	Bolt, crankcase	chrome	5.31	✚
	R446-30	Stud, crankcase 5" black		7.50	✚
	R446-30cad	Stud, crankcase 5" cad			✚
	447-30	Stud, crankcase 6" zinc		12.00	✚
	R447-30	Stud, crankcase 6" black		7.50	✚
	R447-30cad	Stud, crankcase 6" cad			✚
	R0117P	Nut, crankcase stud	park	1.19	✚
	R0117M	Nut, crankcase stud	cad	1.25	✚
	R0117C	Nut, crankcase stud	chrome	0.94	✚
	R0117NI	Nut, crankcase stud	Nickle	1.35	✚



R472-30 Chain guard stud cad 10.00 ✚

Timing Hole Plugs

'31-'36 Standard size plugs 5/8"-18 thread

2326-26	Timing hole plug	park	17.00	⊕
R2326-26P	Timing hole plug	park	10.00	⊕
R2326-26	Timing hole plug	cad	10.63	⊕
R2326-26C	Timing hole plug	chrome	12.50	⊕



R2326-26C



C9407-1

Oversize plugs, to repair stripped threads 11/16"-16 thread

Note: oversize plugs are late style with 3/4" hex size (wrench size).

C9714-1	Oversize plug	park	6.25	⊕
C9404-1	Oversize plug	cad	6.25	⊕
C9304-1	Oversize plug	chrome	9.38	⊕
C9407-1	Tap	11/16"-16	45.00	⊕
C2282-1	Special tap can be used on assemb. cases		45.00	⊕

Heli-Coil® thread repair, 5/8"-18

Repair kit includes 6 inserts, tap and installation tool.

H5528-10-2	Thread repair kit	5/8"-18 thread	n.a.	⊕
HR1191-10-2	Set inserts only	(6)	38.00	⊕



Gear Cover Screws

056	Screw, gear cover	park	1.95	⊕
R056P	Screw, gear cover	park	1.88	⊕
R056	Screw, gear cover	cad	1.88	⊕
R056C	Screw, gear cover	chrome	2.31	⊕
R056NI	Screw, gear cover	Nickle		⊕



Gear Cover Screw Sets, include 12 screws

C9621-12	Stock (slotted) heads	park	22.50	⊕
C8150-12	Stock (slotted) heads	cad	22.50	⊕
C8149-12	Stock (slotted) heads	chrome	27.50	⊕
C8755-12	Allen heads	chrome	29.38	⊕
C7129-12	Acorn heads	chrome	42.50	⊕
C8445-12	Cap heads	chrome	41.25	⊕

M1421T	Tap	1/4"-24	7.00	⊕
die160-005	Die	1/4"-24	n.a.	

Heli-Coil® thread repair

H5540-4	Thread repair kit	1/4"-24	125.00	⊕
----------------	-------------------	---------	--------	---

(includes 12 inserts, tap and installation tool, order drill seperately)

HR389-4	Set Heli-coil inserts only (12)	25.00	⊕	
M6117D	Drill, use with repair kit	17/64"	n.a.	⊕



A. R636-30A	Idler gear stud assembly	15.00	⊕
B. R620-30	Bushing, idling gear	12.00	⊕
C. 636-30	Stud, idling gear	12.00	⊕
" R636-30	Stud, idling gear	8.50	⊕
D. 644-30	Screw, idler gear stud	6.00	⊕
" R644-30	Screw, idler gear stud	5.75	⊕
E. R658-15	Spring ring, idler gear stud	0.60	⊕



A.



C.

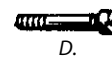

D.



B.



E.

F. R660-30	Bushing, cam gear shaft	17.00	⊕	
G. R662-29	Bushing, timer shaft, right	24.00	⊕	
H. R662-30	Bushing, cam gear shaft, right	21.00	⊕	
J. R662-34	Bushing, oiler drive shaft	'34-'36	21.00	⊕
661-31	Pin, cam bushing	'31-'36	0.80	⊕
R661-31	Pin, cam bushing	'31-'36	0.30	⊕
R663-26	Fibre washer, cam shaft	1/64"	0.80	⊕
R663-26.30pack	30 Fibre washers	1/64"	12.00	⊕
R664-26	Fibre washer, cam shaft	1/32"	0.80	⊕
R664-26.30pack	30 Fibre washers	1/32"	12.00	⊕

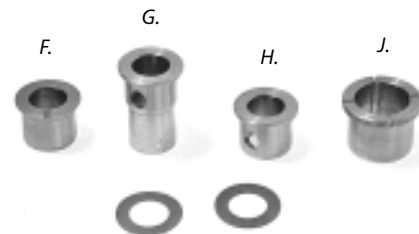

R361-12	Key, pinion gear	2.75	⊕	
0142	Nut, pinion gear	3.00	⊕	
R355-16	Nut, pinion gear - left hand thread	8.50	⊕	
R672-32	Adjusting screw, chain oiler	'33-'36	14.38	⊕
R0202	Washer, adjusting screw	1/16"	0.60	⊕
674-32	Shim, adjusting screw	.002"		⊕
R674-32.10	Shims, adjusting screw (10)	.002"	7.19	⊕
713-34	Cam shaft end plate	'34-'36	12.00	⊕
716-34	Cam shaft lever screw	'34-'36	5.00	⊕
717-34	Lever clamp nut	'34-'36	6.00	⊕
724-34	Cam adjusting stud	'34-'36	14.00	⊕
726-34	Cam adjusting plate	'34-'36	12.00	⊕

(screw with washers/shims)



R672-32

R589-34	Gasket, oil pump	'34-'36	2.00	⊕
R589-34.10pack	10 Gaskets, oil pump		12.00	⊕
R680-34	Gasket, oil pump	'34-'36	2.00	⊕
R680-34.10pack	10 Gaskets, oil pump		12.00	⊕

Exhaust



Exhaust System

R1004-30	Pipe set (2pcs)	bare	195.00 ☼
R1004-30C	Pipe set (2pcs)	chrome	n.a. ☼
R1007-30	Rear pipe only	bare	n.a. ☼
R1007-30C	rear pipe only	chrome	n.a. ☼
R1034-30TT	Muffler, twin tube, 1930	bare	345.00 ☼
R1034-30	Muffler	bare	135.00 ☼
R1034-30C	Muffler	chrome	165.00 ☼
R1034-30-SP	Muffler "exact replica"	bare	295.00 ☼
R1034-34	Muffler, 1934 upsweep style	bare	165.00 ☼
R1034-34C	Muffler, 1934 upsweep style	chrome	185.00 ☼
R1070-34	Rear hanger clamp 1934	park	24.00 ☼
R1064-32	Rear muffler clamp '32-'36		14.00 ☼
R1064-32C	Rear muffler clamp '32-'36	chrome	17.00 ☼
R1061-32	Front pipe clamp '32-'36	park	13.00 ☼
R1061-32C	Front pipe clamp '32-'36	chrome	16.00 ☼
R1061-32BP	Front clamp spacer, bolt and nut	park	8.50 ☼
R1065-32	Clamp reinforcement '32-'36	park	11.50 ☼
R1065-32C	Clamp reinforcement '32-'36	chrome	13.50 ☼
R1030-32	Center exhaust clamp '32-'36	park	39.00 ☼
R1030-32C	Center exhaust clamp '32-'36	chrome	42.50 ☼
Mounts front of muffler to brake crossover tube, includes bolt and nut.			
R1032-32	Clamp bolt only '32-'36	park	9.00 ☼
R0123P	Nut only '32-'36	park	1.50 ☼

Carburetor Manifold Parts

R1115-30P	Nut	1-1/4" carbs	park	17.50 ☼
R1115-30	Nut	1-1/4" carbs	cad	17.50 ☼
R1115-30C	Nut	1-1/4" carbs	chrome	21.25 ☼
R1118-30	Bushing	1-1/4" carbs		10.63 ☼
1121-21	Gasket	1-1/4" carbs	.005"	0.50 ☼
1121-39.5	Gaskets (5)	1-1/4" carbs	NOS	10.00
R1121-39	Gasket	1-1/4" carbs	.062"	2.50 ☼
R1121-29	Gasket	1" carbs		2.00 ☼
1123-29	Screw, 1/4"-24	1" carbs	park	1.50 ☼
R1123-29	Screw, 1/4"-24	1" carbs	cad	3.13 ☼
R1123-29C	Screw, 1/4"-24	1" carbs	chrome	4.05 ☼
1123-30	Screw, 5/16"-18	1-1/4" carbs	park	2.50 ☼
C3357-3	Set of 3 screws	not slotted	cad	9.38 ☼



Special Carburetor Taps and Dies

tap160-002	Tap	1/4"-40	n.a.	High speed needle valve (adjustable & non-adjustable), lever 1292-27.
tap160-003	Tap	1/4"-32	n.a.	Float lever pin and screw (1196-16, 1197-16), bowl drain screw (1269-39)
die160-008	Die	3/4"-20	n.a.	Bowl nut 1268-29 (to repair thread on carburetor body)



A.	R1152-11	Screw, needle valve adjusting	zinc	8.50
"	R1152-11cad	Screw, needle valve adjusting	cad	12.50 ☼
B.	R1153-11	Lockscrew, needle valve		0.40 ☼
C.	R1154-11	Lockspring, needle valve		2.00
E.	R1261-27A	Low speed needle cpt.	1-1/4" carbs	28.75 ☼
F.	R1262-27	Collar, spring		3.00
G.	R1264-27	Spring, needle valve		0.80 ☼
H.	R1293-27	Screw, needle valve lever		3.00 ☼
	1251-33	Plug, idle passage	'33-'36	7.00 ☼
	1263-24	Plug screw, idle passage		3.00 ☼
	R1263-24	Plug screw, idle passage		2.20

L. **R1254-27** High speed needle valve 1-1/4" carbs 33.75
M. **R1254-27S** High speed needle valve 1-1/4" carbs n.a.
This needle has extra long threads to be used when first part of thread in carburetor is damaged. Clean up with 1/4"-40 tap first.

N.	1231-33	Shaft, air intake	'33-'36	n.a.
O.	1232-24	Disc, air intake		n.a.
P.	R1234-24	Screw, intake lever	'33-'36	4.20
R.	R1296-26	Spring, friction		0.80 ☼
S.	R1297-26	Ball, friction		0.35 ☼
	R010Z	Screw, intake disc		0.30
T.	R1242-26	Throttle shaft	1" carbs	12.50 ☼
"	R1243-24	Throttle shaft	1-1/4" carbs	10.00
U.	1244-24	Throttle disc	1-1/4" carbs	13.00 ☼
	R010Z	Screw, throttle disc		0.30
V.	R1245-24	Bushing, throttle shaft		3.00 ☼
W.	R1247-32	Spring, throttle shaft	'31-'36	1.00 ☼

	R27376-52	Gasket, float bowl	K-model '52-'56	2.00 ☼
		(will fit all Flathead models)		
	R1196-11kit	Pin and screw	except late '32 & '33	12.50 ☼
	1197-16	Screw only	except late '32 & '33	5.00 ☼
	R1197-16	Screw only	except late '32 & '33	4.38 ☼
X.	R1265-29A	Venturi	7/8" for 1" carburetor	47.50 ☼
"	R1265-30A	Venturi	1-1/16" for 1-1/4" carburetor	48.44 ☼
"	C2822-1		+0.025" oversize	48.44 ☼
"	R1265-30B	Venturi	1-1/8" for 1-1/4" carburetor	50.00 ☼
"	C3164-1		+0.025" oversize	50.00 ☼
Y.	R1271-33	Float	"Rubber Ducky" '33-'36	44.00 ☼
Z.	R1272-33	Lever, float	'33-'36	12.50
	R1272-33A	Stud and screw, float mount	'33-'36	4.25
AA.	R1273-33A	Float valve & seat	'33-'36	29.06 ☼
AB.	R1275-33	Cap, bowl	brass '33-'36	6.88 ☼
"	R1275-33cad	Cap, bowl	cad '33-'36	6.88 ☼
AC.	R1285-33	Washer, inlet nipple	'33-'36	1.80 ☼
AD.	R1257-33	Spring, nozzle	cad '33-'36	1.20
AE.	R1258-33	Main nozzle	'33-'36	11.00
AF.	1268-29	Nut, bowl lock	cad	15.00 ☼
"	R1268-29	Nut, bowl lock	cad	13.75 ☼
"	R1268-29C	Nut, bowl lock	chrome	16.25 ☼
"	R1268-29B	Nut, bowl lock	brass	17.50 ☼
"	C3121-6	Nut, with drain hole	cad	21.88 ☼
	R1269-28	Gasket, bowl lock nut		2.06 ☼
AG.	R1110-33	Bracket, support	park '33-'36	11.25 ☼
	R0127P	Nut, support bracket	park	1.50 ☼
	R0127	Nut, support bracket	cad	1.63 ☼
	R0127NI	Nut, support bracket	Nickle	1.60 ☼

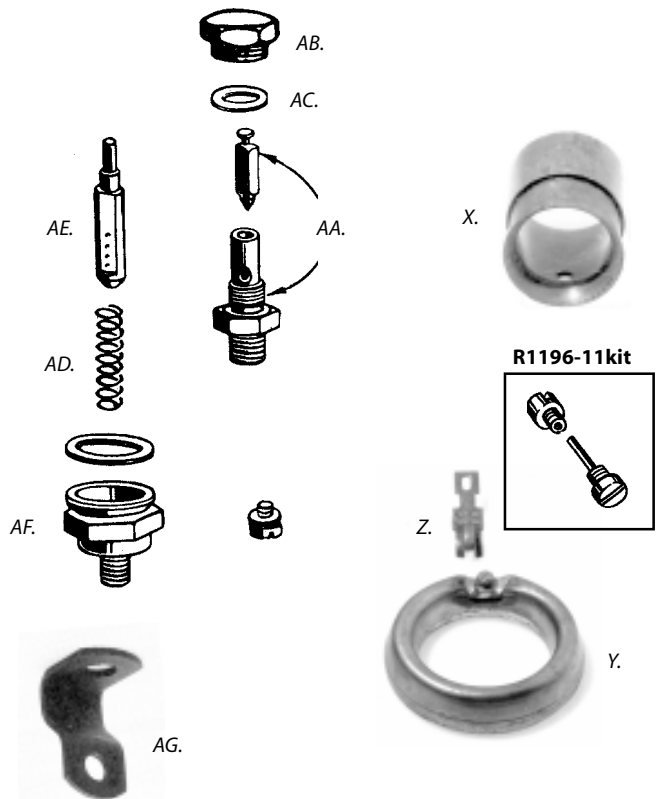
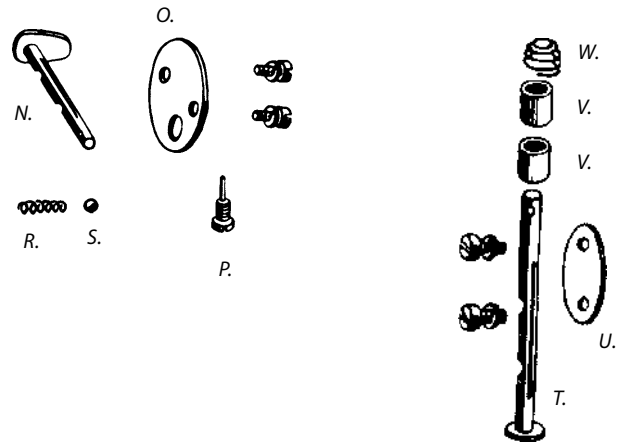
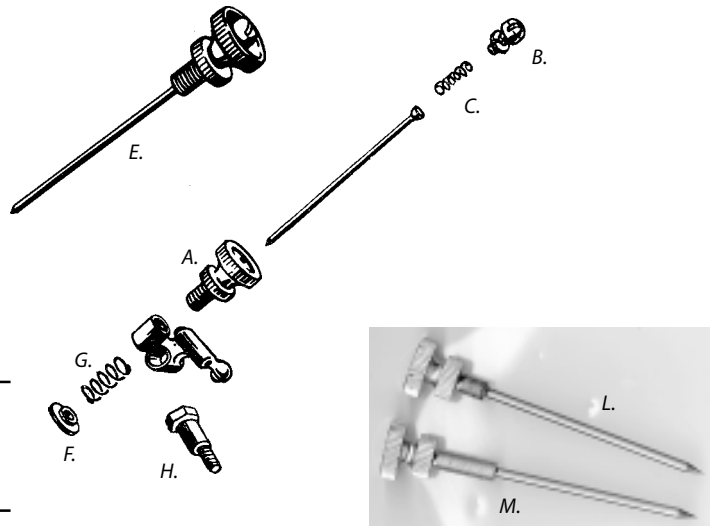

Generator

Generator is '32 and later type, complete unit will fit '30-'36 models.

1501-32 Generator, 6 Volt "32E" three brush, not available
complete except for drive gear and mounting screws.

R1527-30	Gasket, generator		0.70 ☼
R1527-30.10pack	10 Gaskets, generator		5.00 ☼
R30144-32	Shim, paper, use 1, or more if necessary		1.88 ☼

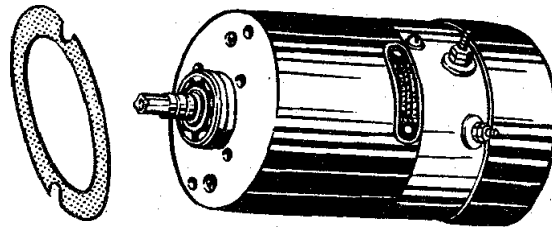

Mounting Parts

R1523-29A	Screw, fastening	cad	5.00 ☼
R1523-30P	Screw, fastening (late style)	park	5.63 ☼
R1523-30	Screw, fastening (late style)	cad	5.63 ☼
R1523-30C	Screw, fastening (late style)	chrome	8.13 ☼
A. 1528-30	Strap, fastening	black	n.a.
" R1528-30C	Strap, fastening	chrome	n.a.
B. R1529-30P	Washer, strap	park	2.06 ☼
" R1529-30	Washer, strap	cad	2.06 ☼
C. 058	Screw, strap		3.00 ☼
D. R0370P	Lockwasher	park	0.50 ☼
" R0370	Lockwasher	zinc	0.30 ☼
E. R0117P	Nut, strap	park	1.19 ☼
" R0117M	Nut, strap	cad	1.25 ☼
" R0117C	Nut, strap	chrome	0.94 ☼
" R0117NI	Nut, strap	Nickle	1.35 ☼
F. R0259P	Lockwasher	park	0.25 ☼
" R0259	Lockwasher	zinc	0.25 ☼
" R0259C	Lockwasher	chrome	0.38 ☼



"late style"

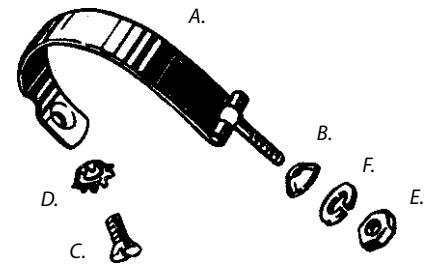

M1421T Tap, 1/4"-24 (mounting screws) 7.00 ☼



Heli-Coil® thread repair

Thread repair kit includes tap, 12 inserts and installation tool.

H5540-4	Heli-Coil thread repair kit	1/4"-24	125.00 ☼
HR389-4	Set Heli-Coil inserts	(12)	25.00 ☼
M6117D	Drill, use with kit	17/64"	5.00 ☼

1696-32	Cover, commutator	black	n.a. ☼
R1696-32C	Cover, commutator	chrome	n.a.
R037P	Screw	park	0.63 ☼
R037	Screw	cad	0.69 ☼
R037C	Screw	chrome	1.13 ☼
R037NI	Screw	Nickle	0.90 ☼
R632-30	Gear, generator		n.a.
R634-32	Pin, generator gear		n.a.

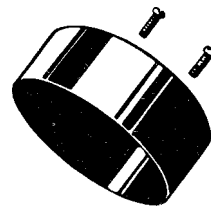

Relay

Electronic, use with 32E three-brush generator. "V-Tronic"

R4785-26	Relay, without cover	'30-'36	47.00
R4786-26DR	Cover	black '30-'36	23.50
R4786-26DRC	Cover	chrome '30-'36	25.00
R051P	Mounting screw	park	1.44 ☼
R051	Mounting screw	cad	1.50 ☼
R051C	Mounting screw	chrome	2.63 ☼

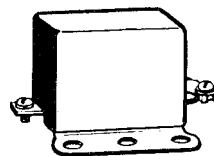

R8375-47	Voltage regulator	6V	99.00
R8375-32	Voltage regulator	12V	99.00

Special electronic regulator designed to convert from three-brush to two-brush generators '32-'57 models.

Without cover. (V-Tronic)

R4786-38DR	Cover	black	20.00
R4786-38DRC	Cover	chrome	21.00

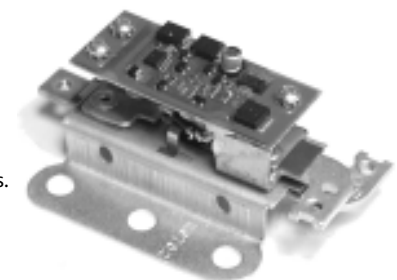

32E Generator Parts

A.	1504-32M	Frame, includes field coils	n.a.
B.	1505-32	End, frame	n.a.
C.	R1506-32	Screw, frame	12-24 8.13 ☼
	H5521-1	Heli-Coil repair kit	12-24 thread 57.00 ☼
D.	R1507-32	Field coil, shunt,	white dot 32.00
E.	R1508-32	Field coil, regulating	orange dot 32.00
	R010Z	Screw	0.30
F.	1512-18E	Screw, pole shoe	3.00 ☼
"	R1512-18	Screw, pole shoe	2.06 ☼
G.	R037	Screw, retainer	cad 0.69 ☼
	R1636-32	Armature, 6V	n.a.
H.	1641-30A	Oil retainer, inner	7.00 ☼
J.	1641-33	Oil retainer, outer	7.00 ☼
K.	R1642-29	Armature end washer, fibre	3.75 ☼
L.	R1642-30	Gasket, bearing housing	1.30 ☼
M.	R1643-29	Washer (.033")	0.80 ☼
"	R1643-29S	Washer (.070")	0.80 ☼
"	1643-30	Washer (.072")	2.00 ☼
N.	R1644-18	Bearing, small	10.00
O.	R1644-30	Bearing, large	11.00
P.	R1646-31	Oil deflector	9.00 ☼
R.	1647-29A	Spring ring, bearing plate	2.00 ☼
	1647-31A	Rivet, bearing housing	0.50 ☼
S.	1647-31B	Spring, drive end	4.00 ☼
"	R1647-31B	Spring, drive end	1.00 ☼
T.	1647-31C	Washer, drive end felt	1.50 ☼
"	1637-46	Oil seal, armature metal O.D.	7.00 ☼
"	R1637-46	Oil seal, armature	2.20 ☼
U.	1647-31D	Ring, drive end spring	3.00 ☼
	1647-31E	Plate, drive end felt washer	5.00 ☼
V.	1647-32	Housing, drive end bearing	17.00 ☼
W.	R1660-32	Positive brush holder assembly	n.a.
X.	1661-32	Holder, main brush	12.00 ☼
Y.	1662-32	Holder, third brush	n.a. ☼
	R010Z	Screw	0.30
AA.	R1663-32	Insulation, positive brush holder	0.85
AB.	R1663-32A	Insulation, field coil terminal	0.60
AC.	R1664-32	Screw, positive terminal	6.25 ☼
AD.	R1664-32A	Complete terminal	10.31 ☼
AE.	R1665-32	Bushing	1.80 ☼
AF.	R1666-32	Washer, insulating	1.75 ☼
AG.	R0354	Lockwasher	0.20
AH.	0105cop	Nut, terminals	copper 0.70 ☼
"	0105copM	Nut, terminals (machined)	copper 1.30 ☼
	M6131DI	Die, 10-32 thread	n.a. ☼
AK.	1697-30	Gasket	1.00 ☼
AL.	R036	Screw, terminal	cad 0.69 ☼
AM.	1667-32	Nut, brush holder	1.50 ☼
	1669-32A	Brushes, set (3)	20.00 ☼
	R1669-32A	Brushes, set (3)	10.00
	R1674-26	Spring only, third brush	1.00
	R1674-32	Spring only, main brush	1.00

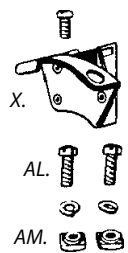
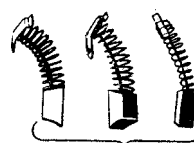
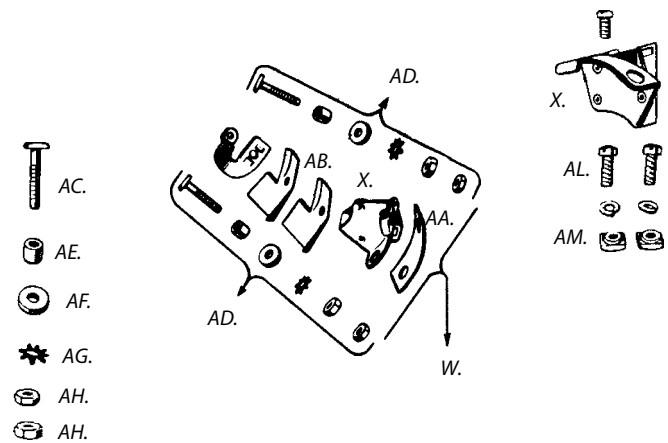
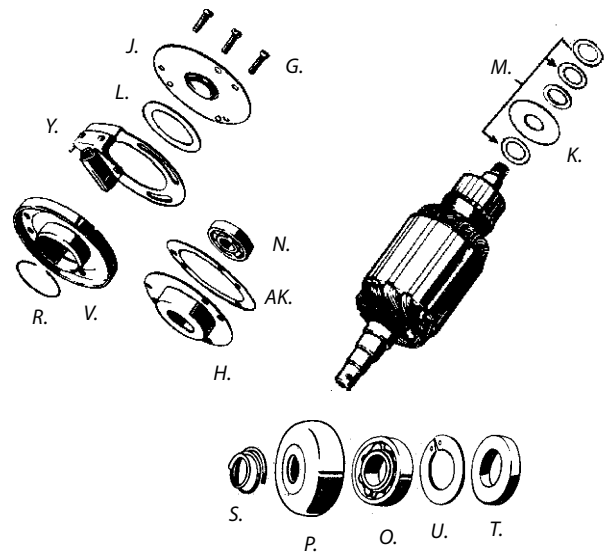
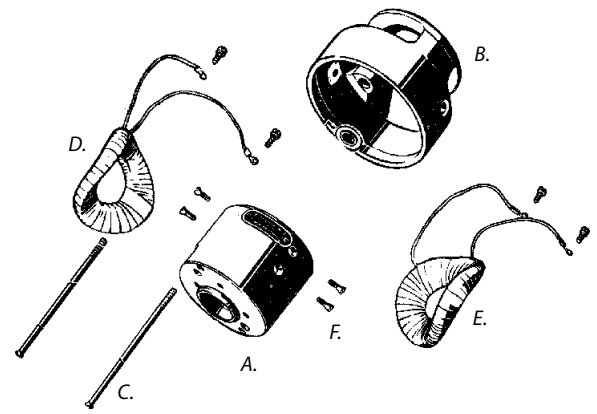

Timer / Spark Coil

R1569-30A	Points set, breaker (with spring)	9.00
R1569-30A.10pack	10 Points sets	67.50
R1574-30	Spring only, breaker points	0.70 ✖
R018	Screw, breaker points fastening	0.63 ✖
R1571-30	Circuit breaker rebuild kit (stud) with tool	23.75 ✖
R035	Screw, circuit breaker mounting cad	0.69 ✖
R1618-30	Washer, insulating	1.88 ✖
R1629-30	Condenser (original style)	5.00
R1629-30.10pack	10 Condensers (original style)	40.00
R1629-47	Condenser (late style)	3.00
R1629-47.10pack	10 Condensers (late style)	24.00
1614-18	Terminal and eyelet	3.00 ✖

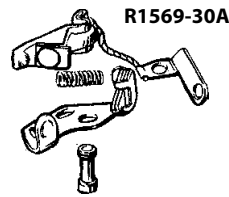

R1571-30



R1629-47



1614-18

Spark Coils

R1722-29K6	Coil, round model 6 Volt black	34.00
Includes late style mounting bracket, custom fit on '47-earlier models.		
R1722-29K6.5pack	5 Coils with cables	145.00
R1722-29K6.10pack	10 Coils with cables	255.00



Coil Mounting

A.	R1723-29	U-bolt, with nuts	park '30-'32	13.75 ✖
	R0107P	Nut only	park '30-'32	1.13 ✖
	R0107C	Nut only	chrome '30-'32	1.13 ✖
"	1723-30	U-bolt, with nuts	park '33-'36	12.50 ✖
	0109	Nut only	park '33-'36	2.00 ✖
	0109C	Nut only	chrome '33-'36	2.30 ✖
B.	R1724-29	Strap, for U-bolt	'30-'36	13.75 ✖
C.	R1725-30P	Screw, coil mounting	1/4"-28 '30-'32	1.88 ✖
D.	R1726-30P	Screw plate	1/4"-28 '30-'32	5.63 ✖
E.	1728-30	Plate, coil mounting	'30-'32	22.00 ✖
"	R1728-30	Plate, coil mounting	'30-'32	14.38 ✖
	C2327-23	Mounting kit	'30-'36	73.75 ✖
	R021P	Screw, coil terminal	park	0.63 ✖
	R021	Screw, coil terminal	cad	0.63 ✖
	R021C	Screw, coil terminal	chrome	0.60 ✖

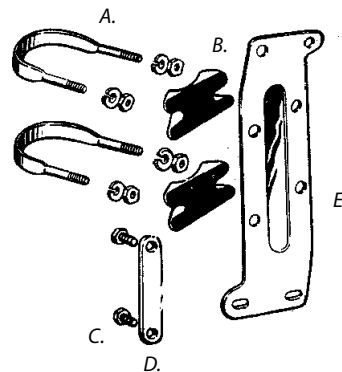

C2327-23

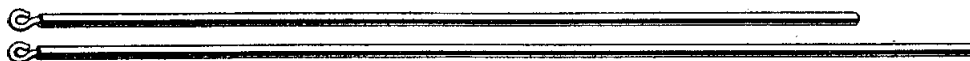

R1596-32	Kit, spark plug cable(hooked ends)	n.a.
R1596-30	Spark plug cable, rubber	per meter 6.00
R1599-27	Cable packing washer (seal) rubber	2.50 ✖
R1599-27A	Cable packing nut cad	8.75 ✖
R0211P	Washer	0.63 ✖
C7804-6	Set packing nuts & washers cad	22.50 ✖

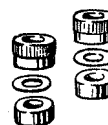

C7804-6

R2028-30	Motor sprocket	21 T	
R2028-30B	Motor sprocket	22 T	23.00
R2030-30	Motor sprocket	23 T	29.00
R2030-30B	Motor sprocket	24 T	23.00
R2031-30	Motor sprocket	25 T	23.00
R2050-30	Nut, motor sprocket		13.75 ☼
R361-12	Key, motor sprocket		2.75 ☼
R2049-30A	Rear wheel sprocket 51 T, with rivets		32.00
R4034-30	Dust ring, brake drum		8.50
R2048-35kit	Rivet & dowel pin kit		10.00 ☼

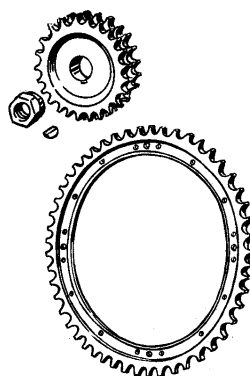

R12039-38	Chain tool (rear chain only)	6.00
R12039-X	Chain tool (front/rear chain)	12.00

R2001-30D	Front chain	90 links	n.a. ☼
R2003-102	Rear chain 3/8" x 5/8"	102 links	65.00 ☼
R2003-106	Rear chain 3/8" x 5/8"	106 links	50.00 ☼
R2003-110	Rear chain 3/8" x 5/8"	110 links (chains include connecting link)	75.00 ☼
2006-15	Link, connecting	"Diamond" rear	3.00 ☼
2015-15	Link, double repair	"Duckworth" rear	5.00 ☼
2007-39	Link, connecting	"Duckworth" front	8.00 ☼
2015-39	Link, double repair	"Duckworth" front	10.00 ☼

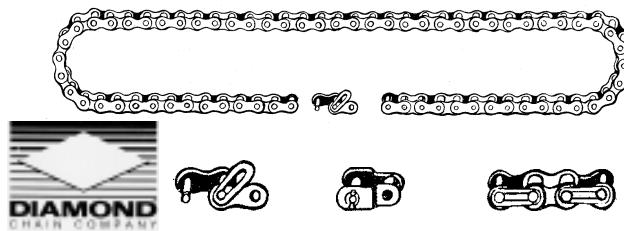

Starter

R2080-16	Lockwasher, starter crank		1.15
2084-24	Spring, starter crank		n.a. ☼
R2092-16C	Starter pedal, bicycle type		n.a.
R2092-17	Rubber, pedal	black	10.00 ☼
R2092-17BL	Rubber, pedal	blue	5.00 ☼
R2092-17G	Rubber, pedal	green	5.00 ☼
R2092-17R	Rubber, pedal	red	5.00 ☼
R2092-17W	Rubber, pedal	white	n.a.
R2093-17P	Rod, pedal rubber	park	10.00 ☼
R2093-17	Rod, pedal rubber	cad	10.00 ☼
R2095-16	Pedal axle	park	30.00 ☼
R2096-17P	Cover, pedal axle	park	8.13 ☼
R2096-17	Cover, pedal axle	cad	8.13 ☼
R0224P	Washer, pedal axle	park	0.63 ☼
R0261P	Lockwasher	park	0.25 ☼
0129	Nut, pedal axle	park	1.50 ☼
R0129P	Nut, pedal axle	park	1.44 ☼
R2099-29P	End cover	park	12.50 ☼
R2099-29	End cover	cad	12.50 ☼
R2101-31	Bushing, pedal pin		1.00
R2102-30	Spring washer, pedal pin		0.70
2100-16	Bolt "dome head"	park	8.00 ☼
R2100-16C	Bolt "dome head"	chrome	9.38 ☼
R0104P	Nut, pedal rod	park	0.50 ☼
R0104Z	Nut, pedal rod	zinc	0.40 ☼
R0104C	Nut, pedal rod	chrome	0.75 ☼
R0254P	Lockwasher	park	0.25 ☼
R0254	Lockwasher	zinc	0.20 ☼
R0254C	Lockwasher	chrome	0.38 ☼
2144-31	Starter sector gear	'31-'36	85.00 ☼
2155-31	Starter main shaft gear	'31-'36	n.a. ☼
R2155-31A	Bushing, starter O.D. 0.924"	'31-'36	28.00 ☼
R2155-31B	Bushing, starter O.D. 0.907"	'31-'36	23.50 ☼

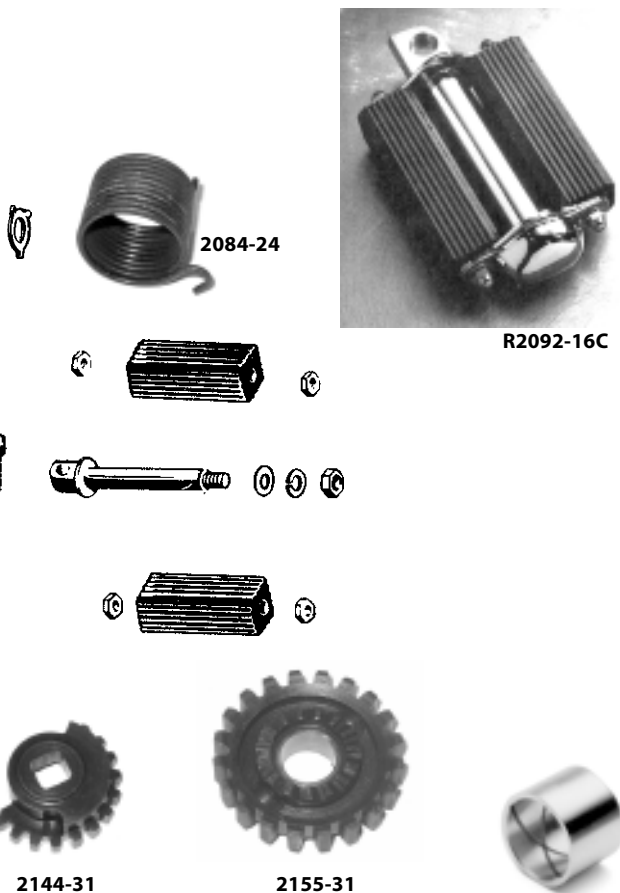

Transmission cover mounting kits '15-'30

C2377-36	Transmission top cover kit	Nickel	54.38 ☼
C2379-36	Transmission top cover kit	park	50.00 ☼
C2381-24	Transmission side cover kit	Nickel	35.00 ☼
C2382-24	Transmission side cover kit	park	33.75 ☼

Transmission cover mounting kits '31-'36

C2380-36	Transmission top cover kit	park	50.00 ☼
C2383-24	Transmission side cover kit	park	33.75 ☼



Shifter / Clutch

Shifter Parts

A.	2205-31	Ball, gear shifter	black	'31-'36	n.a.
"	R2205-31B	Ball, gear shifter	brass	'31-'36	n.a.
"	R2205-31C	Ball, gear shifter	chrome	'31-'36	n.a.
(Shifter balls are '41-up style)					
	R2206-16	Stud, gear shifter	Nickle		18.12 ☼
	R2206-16cad	Stud, gear shifter	cad		18.12 ☼
B.	R2210-16C	Nut, shifter guide clamp	chrome		17.50 ☼
"	R2210-16NI	Nut, shifter guide clamp	Nickle		16.25 ☼
C.	R2212-30	Shifter rod	cad	'30-'35	n.a. ☼
D.	R4068-14	Clevis, shifter rod end	cad	'30-'36	21.88 ☼
E.	R2225-30	Bolt, shifter rod end	cad	'30-'36	15.00 ☼
		(includes collar 2226-30)			
	R0125P	Nut, shifter shaft	park	'30-'36	1.50 ☼
	R2227-30	Shifter lever, short	park	'30-'36	26.25 ☼
	R0112P	Nut, cover stud	park		1.25 ☼
	R0112	Nut, cover stud	cad		1.38 ☼
	R0112NI	Nut, cover stud	Nickle		1.50 ☼
	R0213P	Washer, stud nut	park		0.50 ☼
	R0213NI	Washer, stud nut	Nickle		0.63 ☼

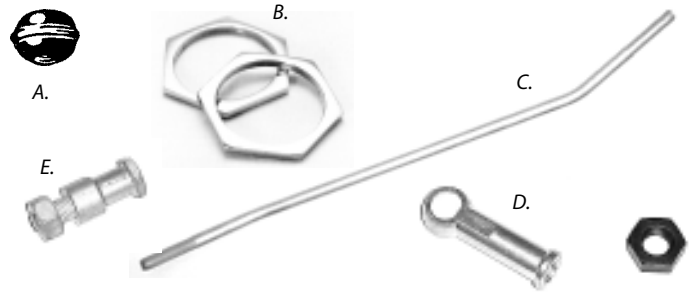

(bearing rollers; see page 38)

J.	R2287-17	Spring washer			3.00 ☼
K.	R2288-17	Plate, roller bearing			8.00 ☼
	R2132-26	Gasket, side cover			3.00 ☼
	R2261-15	Gasket, top cover			1.50 ☼
L.	R2163-15	Oil retainer, small			17.00
M.	R2294-15	Oil retainer, large			18.00
N.	R35094-65	Bushing, main drive gear		'31-'36	38.50 ☼
O.	R2300-32	Countershaft		'32-'36	n.a.
P.	R2308-16set	Set end play washers			35.00 ☼
		(includes 7 washers; .076"-.100")			
R.	R2309-16	Collar, countershaft bearing			4.50 ☼
	R2309-32	Thrust washer, countershaft - inner			4.50 ☼
	R2312-16	Mounting collar, left	std.		22.00 ☼
	R2312-16B	Mounting collar, left	+.002"		23.00 ☼
	R2312-16C	Mounting collar, left	+.005"		24.00 ☼
	R2326-17	Oil filler plug		'17-'29	15.00 ☼
	R2326-17keep	Oil filler plug "keep filled"		'17-'29	15.63 ☼
	R2318-15	Stud, transmission bottom	park		5.31 ☼
	R0125P	Nut, bottom stud	park		1.50 ☼
T.	R453-10A	Drain plug, gear box	cad		7.50 ☼
U.	R2328-25	Screw, front chain adjuster	cad		18.75 ☼
	R2335-15	Mainshaft locknut			15.63 ☼

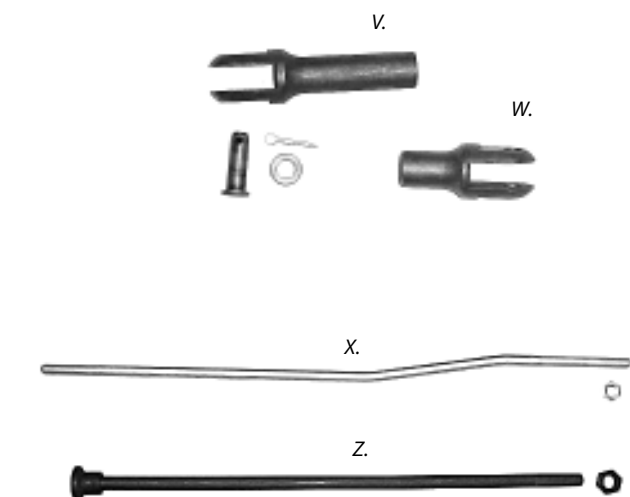

Clutch Parts

	R2411-32	Spring stud	'32-'36	park	10.63 ☼
	0129	Nut, friction stud	'30-'35	park	1.50 ☼
	R0129P	Nut, friction stud	'30-'35	park	1.44 ☼
	0142	Nut, friction stud	'36	park	3.00 ☼
V.	R2422-30	Clevis, clutch rod, front		park	n.a. ☼
W.	R2422-30A	Clevis, clutch rod, rear		park	n.a. ☼
"	R2422-30AC	Clevis, clutch rod, rear		chrome	6.00
	2423-30	Pin, clutch rod clevis			1.00 ☼
	0207	Washer, clevis pin		park	1.00 ☼
	R0290P	Cotter pin, clevis pin		park	0.19
	R0290	Cotter pin, clevis pin		zinc	0.15
X.	R2424-30	Clutch rod	'30-'35	cad	n.a. ☼
	R0117P	Nut, clutch rod		park	1.19 ☼
	R0117M	Nut, clutch rod		cad	1.25 ☼
	R0117C	Nut, clutch rod		chrome	0.94 ☼
	R0117NI	Nut, clutch rod		Nickle	1.35 ☼
Z.	R2445-30	Pull rod 13-9/16" long		park	33.00 ☼
	R0125P	Nut, pull rod		park	1.50 ☼
	R2470-15	Key, clutch hub			1.50

A.	R2634-30AP	Top nut	park	'30-'35	2.50 ☉
"	R2634-30A	Top nut	cad	'30-'35	2.50 ☉
"	R2634-30AC	Top nut	chrome	'30-'35	3.44 ☉
"	R2634-36E	Top nut, acorn	park	1936	7.00 ☉
"	R2634-36EC	Top nut, acorn	chrome	1936	7.60 ☉
B.	2634-30	Nut, spring rod	park		14.00 ☉
"	R2634-30P	Nut, spring rod	park		7.50 ☉
"	R2634-30	Nut, spring rod	cad		7.81 ☉
"	R2634-30C	Nut, spring rod	chrome		8.13 ☉

Top Nut Sets

C9416-4	Cad upper nuts, chrome top nuts	'30-'35	23.75 ☉
C9417-4	Cad upper nuts, park top nuts	'30-'35	23.75 ☉
C2986-4	Cad upper nuts, chrome top nuts	1936	26.25 ☉

C.	R2618-30A	Spring, upper outer (14.5cm)	park		8.00
"	R2618-30AB	Spring, upper outer (14.5cm)	black		9.00
"	R2618-30AC	Spring, upper outer (14.5cm)	chrome		14.00
D.	R2631-30	Spring rod (includes check spring)	park	'30	31.25 ☉
"	R2631-31	Spring rod (includes check spring)	park	'31-'36	30.00 ☉
E.	R2632-31P	Bushing, spring rod	park	'31-'36	23.75 ☉
"	R2632-31	Bushing, spring rod	cad	'31-'36	23.75 ☉
"	2633-30A	Nut, spring rod, bottom end			2.00 ☉

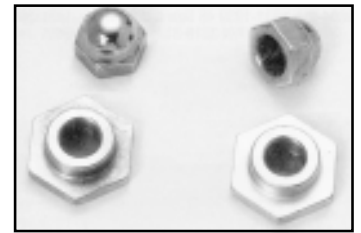
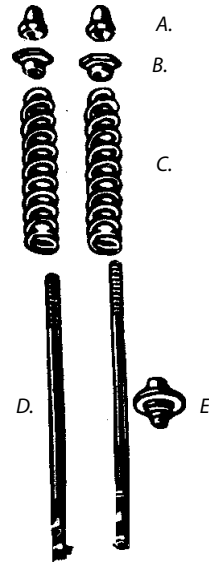

C7613-2

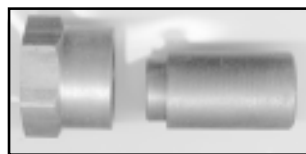
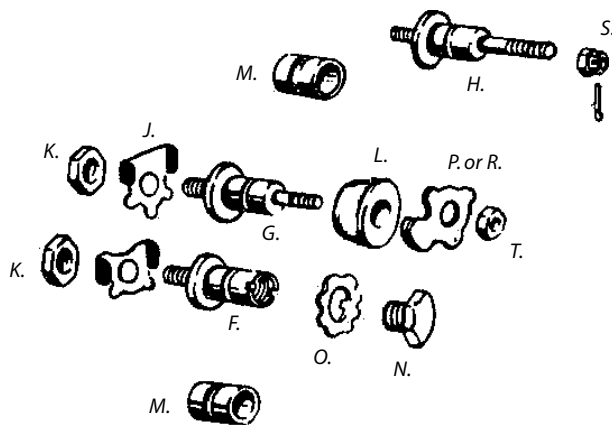

C7611-2

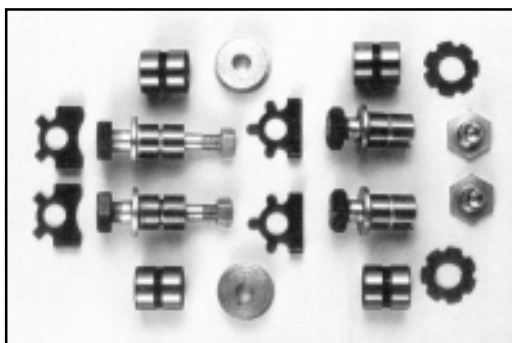

C7606-26

Rocker Parts

F.	2639-31	Rear stud	park	'31-'36	18.00 ☉
"	2639-31cad	Rear stud	cad	'31-'36	20.00 ☉
G.	R2640-31	Front stud, short	cad	'31-'36	35.00 ☉
H.	2640-31E	Front stud, long	park	'31-'36	10.00 ☉
"	2640-31Ecad	Front stud, long	cad	'31-'36	10.00 ☉
(long stud is used with front stand)					
	R3011-30	Spacer, front stand	park		3.75 ☉
	2641-30	Nut, rocker plate stud	park	1930	2.00 ☉
	R2641-30	Nut, rocker plate stud	cad	1930	2.50 ☉
	2641-30C	Nut, rocker plate stud	chrome	1930	3.00 ☉
	R2642-30	Lockwasher	park	1930	2.81 ☉
J.	R2642-31A	Lockwasher, front	park	'31-'36	2.81 ☉
K.	R2643-31	Nut, rocker stud	park	'31-'36	2.13 ☉
"	R2643-31cad	Nut, rocker stud	cad	'31-'36	2.19 ☉
L.	R2644-31P	Spacer, front stud	park	'31-'36	6.25 ☉
"	R2644-31	Spacer, front stud	cad	'31-'36	6.25 ☉
M.	R2645-30	Bushing, rocker plate		'31-'36	14.38 ☉
"	R2645-30S	Bushing, rocker plate +.003"		'31-'36	16.25 ☉
	C7611-2	Bushings installation tool		'31-'36	26.25 ☉
N.	2646-32	Screw, rear stud	park	'32-'36	10.00 ☉
"	R2646-32cad	Screw, rear stud	cad	'32-'36	7.50 ☉
O.	2647-32	Lock, rear stud screw	park	'32-'36	5.00 ☉
"	R2647-32	Lock, rear stud screw	park	'32-'36	3.13 ☉
P.	3732-34	Brace clip lock, left	park	'34-'36	9.00 ☉
"	R3732-34	Brace clip lock, left	park	'34-'36	6.88 ☉
R.	3732-34A	Brace clip lock, right	park	'34-'36	9.00 ☉
"	R3732-34A	Brace clip lock, right	park	'34-'36	6.88 ☉
S.	R0128P	Castle nut, use with long stud	park		2.00 ☉
"	R0128	Castle nut, use with long stud	cad		2.13 ☉
"	R0128C	Castle nut, use with long stud	chrome		2.31 ☉
"	R0128NI	Castle nut, use with long stud	Nickle		2.00 ☉
T.	0129	Nut, short rocker stud	park		1.50 ☉
"	R0129	Nut, short rocker stud	cad		1.56 ☉
"	R0129C	Nut, short rocker stud	chrome		1.75 ☉

Rebuild Kits '32-'36

include studs, bushings, nuts, lockwashers, etc.
Note: these kits include the '41-up spacers.

R2638-36	Kit with short studs	cad/park	195.00 ☉
C2939-26	Kit with short studs (Colony)	park/park	218.75 ☉
C7606-26	Kit with short studs (Colony)	cad/park	218.75 ☉
R2638-36B	Kit with long studs		145.00 ☉

(long studs are used for fitting front stand)

Steering Damper / Footboards

Steering Damper

A.	R2783-30	Washer, steering damper	bakelite	2.00
B.	R2784-30P	Washer, adjusting	park	6.25 ☼
"	R2784-30	Washer, adjusting	cad	6.25 ☼
"	R2784-30C	Washer, adjusting	chrome	8.75 ☼
C.	R2785-30P	Nut, adjusting	park	7.50 ☼
"	R2785-30	Nut, adjusting	cad	7.50 ☼
"	R2785-30C	Nut, adjusting	chrome	10.63 ☼
D.	R2787-30	Release spring		4.00
E.	R2788-30	Washer, release spring		1.00
F.	R2790-30	Washer, fibre friction		4.00
G.	2791-30	Disc, steel	park	14.00 ☼
			('39-up style)	
H.	0129	Nut, damper rod	park	1.50 ☼
"	R0129P	Nut, damper rod	park	1.44 ☼
"	R0129	Nut, damper rod	cad	1.56 ☼
"	R0129C	Nut, damper rod	chrome	1.75 ☼

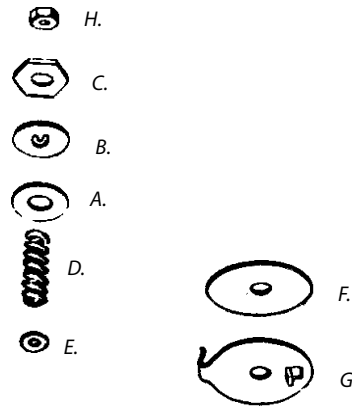

Rear Chain Adjusters

C2069-5	Kit	cad/park	25.00 ☼
R2826-30	Screw, rear axle adjusting	cad	12.50 ☼
R3011-30	Spacer	park	3.75 ☼

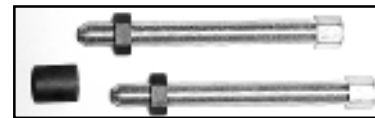

C2069-5

Footboards

R2938-14	Set of footboards, bare (without mats)		n.a. ☼
R2938-14B	Set of footboards, black (without mats)		n.a. ☼
R2941-14	Set of footboard mat rivets (28)		6.95 ☼
R2941-42M	Set of footboard mat rivets (28) shorter		7.95 ☼
C2604-12	Set mounting studs (4)	park	51.25 ☼
2945-14	Rivet, footboard		1.00 ☼
2952-35	Washer, spacing	'35-'36 park	2.50 ☼
R2954-14	Footboard hinge bolt	park	4.45 ☼
0108	Nut	park	1.50 ☼
R0108P	Nut	park	1.13 ☼
R0256P	Lockwasher	park	0.25 ☼
C9886-12	Hinge bolt kit	park	16.25 ☼
R13344-33	Set footboard extensions	park	n.a. ☼
R13344-33C	Set footboard extensions	chrome	n.a. ☼

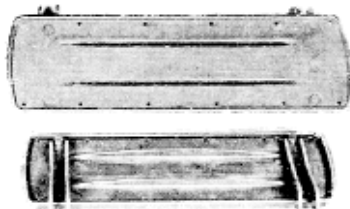

C9886-12

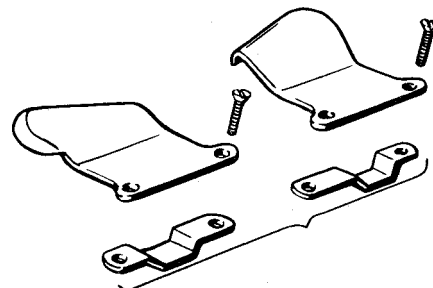

Rear Stand Parts

R3060-26	Shoulder bolt, rear stand	park	10.00 ☼
R3061-24P	Spring, rear stand	'30-'35 park	2.19 ☼
C8840-10	Mounting kit	'30-'35 park	23.75 ☼
	(mounting kit includes two bolts with springs and nuts)		



	3111-12	Pin, cotter pin type	park	1.50	⊗
	3111-12.10pack	10 Pins, cotter pin type		10.00	⊗
A.	3111-29	Pin, seat bar clevis	park	7.00	⊗
"	R3111-29	Pin, seat bar clevis	park	2.00	
"	R3111-29.10pack	10 Pins, seat bar clevis		15.00	
B.	R3112-29	Spring, pin		4.75	
C.	3113-29	Bushing, seat post		11.00	⊗
"	3113-29.4pack	Bushings, seat post (in frame)'29-'73		36.50	⊗
	C2087-1	Seat post bushing installer		17.81	⊗
D.	3117-29	Link, plunger		n.a.	
E.	3118-29	Rivet, plunger link		5.00	⊗
F.	3119-13	Bushing, plunger link		6.00	⊗
G.	R3107-25	Seat tee pivot bolt		18.75	⊗
	R0340	Grease nipple, Alemite	Nickle	3.75	⊗

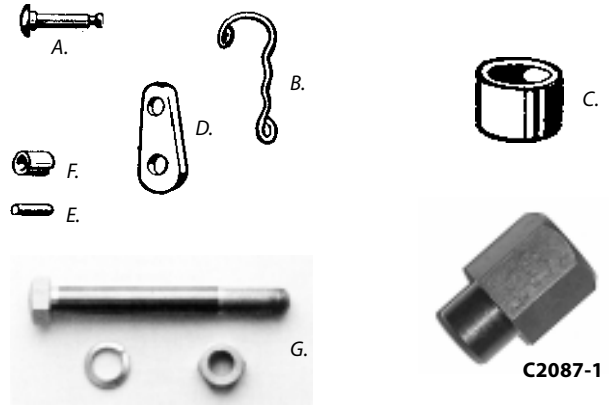

Solo Seat Mounting

H.	3187-34	Bolt, front	'34-'36	park	5.00	⊗
"	R3187-34	Bolt, front	'34-'36	cad		⊗
J.	3189-34	Washer	'34-'36	park	4.00	⊗
"	R3189-34	Washer	'34-'36	cad	3.13	⊗
K.	R0225P	Washer		park	0.63	⊗
L.	R0261P	Lockwasher		park	0.25	⊗
"	R0261	Lockwasher		zinc	0.25	⊗
"	R0261C	Lockwasher		chrome	0.38	⊗
M.	0129	Nut		park	1.50	⊗
"	R0129P	Nut		park	1.44	⊗
"	R0129	Nut		cad	1.56	⊗
"	R0129C	Nut		chrome	1.75	⊗

N.	3205-34	Stud	'34-'36	park	n.a.	⊗
"	R3205-34	Stud	'34-'36	park	4.06	⊗
O.	R3209-31P	Spacer 1/4"	'31-'36	park	3.13	⊗
"	R3209-31	Spacer 1/4"	'31-'36	cad	3.13	⊗
"	R3209-38P	Spacer 1/2"	'31-'36	park	3.13	⊗
"	R3209-38	Spacer 1/2"	'31-'36	cad	3.13	⊗
R.	R0259P	Lockwasher		park	0.25	⊗
"	R0259	Lockwasher		zinc	0.25	⊗
"	R0259C	Lockwasher		chrome	0.38	⊗
S.	R0117P	Nut		park	1.19	⊗
"	R0117M	Nut		cad	1.25	⊗
"	R0117C	Nut		chrome	0.94	⊗
"	R0117NI	Nut		Nickle	1.35	⊗

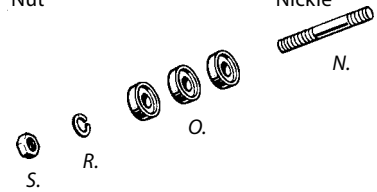
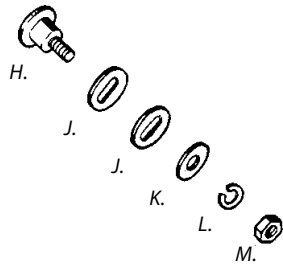

Solo Seat Mounting Kit, '34-'36

Includes front bolt and washers, rear studs with spacers, etc.

C9696-18	Solo seat mounting kit	park	40.00	⊗
C8873-18	Solo seat mounting kit	cad	40.63	⊗

C8873-18

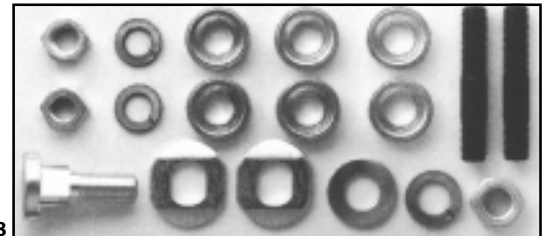

Seat Post

Seat Post Springs and Parts

A.	R3128-31	Spring, cushion	5-1/8"	12.00
B.	3129-31	Spring, cushion	2-3/4"	5.00 ☼
C.	R3129-31C	Spring, extra heavy	3-3/16"	11.00
"	R3129-31A	Spring, extra heavy, with collar guides		18.00
D.	R3133-30	Spring, recoil	1"	3.50
E.	R3135-30	Spring, auxiliary	2-15/16"	4.00
F.	R186-10	Spring, auxiliary	2-7/16"	5.00

Note: Auxiliary springs fit in plunger above rod.

G.	R3138-31	Collar guide, standard springs		5.63 ☼
"	R3138-29A	Collar guide, heavy springs		5.63 ☼

H.	R3137-30	Rod, 15 3/4" / 40 cm	standard length	41.25 ☼
"	R3137-30S	Rod, 16 3/4" / 42,5 cm	extra long	31.00 ☼

J.	3141-29	Nut, plunger lock		18.00 ☼
K.	3143-25	Nut, seat post rod		3.50 ☼

L.	3144-25	Nut, rod lock	park	5.00 ☼
M.	R0269P	Lockwasher	park	1.50 ☼
N.	3147-29A	Nut, spring adjusting		3.50 ☼
O.	0129	Nut, lock	park	1.50 ☼
"	R0129P	Nut, lock	park	1.44 ☼

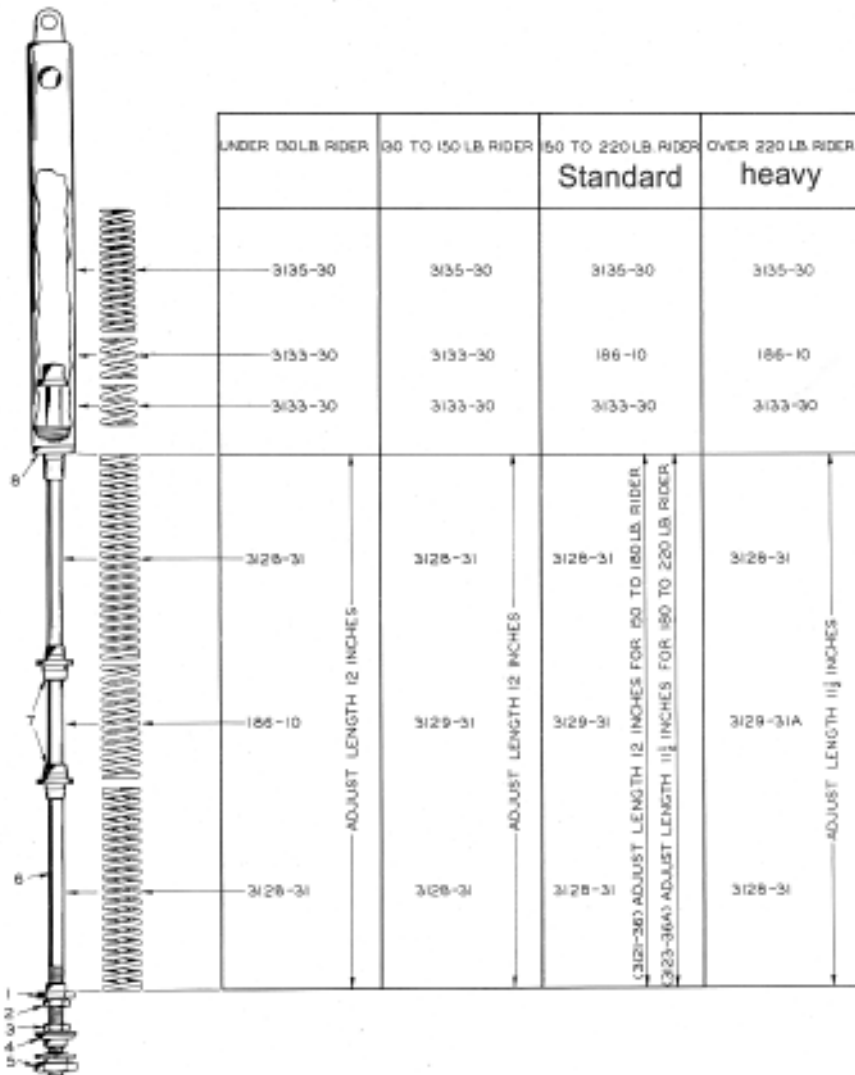
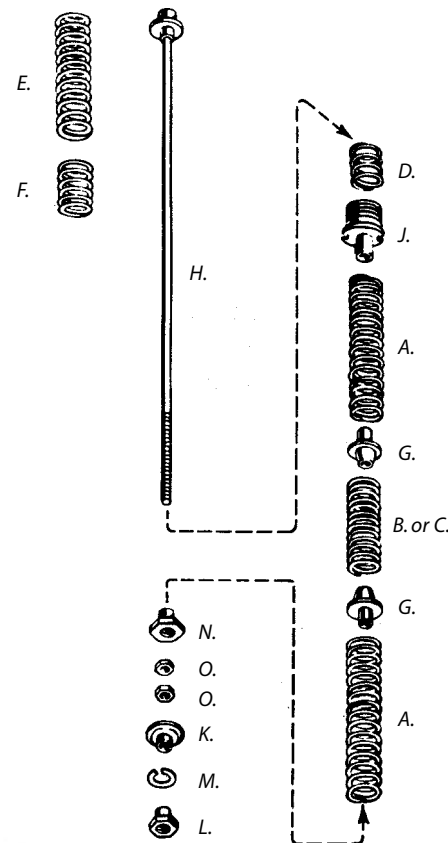

Seat Post Spring Sets

Seat post spring sets are available standard or extra heavy, depending on weight of rider, see chart. If lighter spring set is needed, order springs separately. Each set also includes two spring guides, except set **3128-29**, which includes only one (as original).

Standard spring sets

3128-29	Lower springs only	(3)	32.00 ☼
R3128-31A	Complete set	(6)	37.00
R3128-31A.5pack		5 Sets	155.00

Extra heavy spring sets

R3128-29A	Lower springs only	(3)	33.00
R3128-31B	Complete set	(6)	45.00
R3128-31B.5pack		5 Sets	185.00

Handlebar Spirals and Parts

	R3310-09	Pair of handlebar grips	black	'16-'34	n.a.
	R3310-35B	Pair of handlebar grips	black	'35-'48	8.00
	R3310-35W	Pair of handlebar grips	white	'35-'48	9.00
A.	R3312-16	Spiral	bare	'30-'34	n.a.
"	R3312-16C	Spiral	chrome	'30-'34	n.a.
"	R3312-16NI	Spiral	Nickle	'30-'34	n.a.
"	R3312-35	Spiral	bare	'35-'36	n.a.
"	R3312-35C	Spiral	chrome	'35-'36	n.a.
"	R3312-35A	Spiral, left throttle	bare	'35-'36	n.a.
"	R3312-35AC	Spiral, left throttle	chrome	'35-'36	n.a.
B.	R3314-35C	Replacement sleeve	chrome	'30-'36	n.a.
"	R3314-16NI	Replacement sleeve	Nickle	'30-'36	n.a.
C.	R3316-31	Handlebar plunger		'31-'36	20.00 ☼
D.	305-15	Plunger pin			1.50 ☼
E.	R3320-10	Roller, plain			2.50 ☼
F.	R3321-31	Roller, block		'31-'36	3.13 ☼
G.	R3322-31	Screw, wire fastening		'31-'36	3.13 ☼
H.	R3324-09	Control wire end			1.25 ☼
	C8923-8	Handlebar roller & pin kit		'31-'36	22.50 ☼
J.	R3330-36	Nut, handlebar end	park	'30 (57/64"-24)	8.75 ☼
"	R3330-31	Nut, handlebar end	park	'31-'36 (13/16"-24)	9.38 ☼
K.	R3333-31	Screw, control coil plug		'31-'36	1.25 ☼

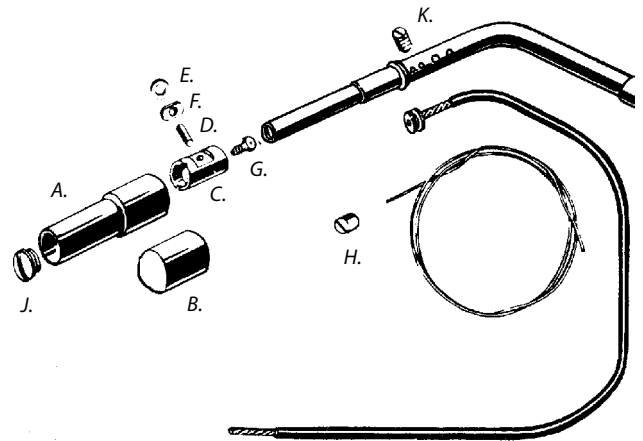

C8923-8

Handlebar Control Cables

L.	R3334-12	Control cable	130 cm	Nickle	n.a.
"	R4143-12	Control cable	215 cm	Nickle	n.a.
"	R3334-32	Control cable	130 cm	pvc	37.50 ☼
"	R3334-39	Control cable	130 cm	cotton	n.a.
	R3326-09	Wire, control	150cm		4.50 ☼
	R3324-09	Nipple, control wire end			1.25 ☼
M.	R3341-28	Adjusting sleeve		park	7.50 ☼
"	R3341-29	Adjusting sleeve, lower		park	13.75 ☼
N.	0129	Nut, adjusting sleeve		park	1.50 ☼
"	R0129P	Nut, adjusting sleeve		park	1.44 ☼
O.	R3370-29	Connection, carburetor		park	n.a.

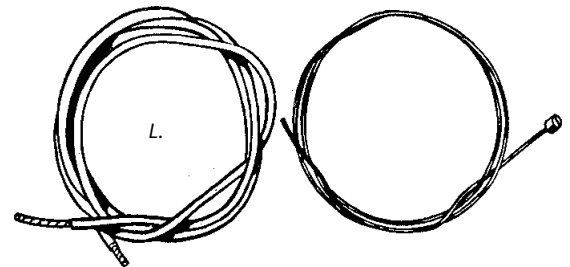

Petrol & Oil Tank

R2210-16C	Nut, shifter guide clamp	chrome	17.50 ☼
R2210-16NI	Nut, shifter guide clamp	Nickle	16.25 ☼



R3507-16	Tank cap	chrome '30-'34	n.a.
R3507-35	Tank cap	chrome '35-'36	n.a.



R3507-16



R3507-35

Tank Mounting Screws

A.	R3529-10P	Screw, tank clip	park	6.25 ☼
"	R3529-10	Screw, tank clip	Nickle	6.25 ☼
B.	0108	Nut, tank screw	park	1.50 ☼
"	R0108P	Nut, tank screw	park	1.13 ☼
"	R0108NI	Nut, tank screw	Nickle	1.56 ☼
	R3530-25	Spacer, tank clip screw		6.25 ☼
	C2463-8	Set screws with spacers		26.88 ☼



Tank Top Screws

C.	R3532-18P	Screw	7/32"-32	park	4.38 ☼
"	3532-18	Screw	7/32"-32	cad	5.00 ☼
"	R3532-18	Screw	7/32"-32	cad	4.38 ☼
"	R3532-18C	Screw	7/32"-32	chrome	n.a. ☼
"	R3532-18NI	Screw	7/32"-32	Nickle	4.38 ☼
"	3532-18S	Screw, oversize	1/4"-32	park	4.00 ☼
"	R3532-18SP	Screw, oversize	1/4"-28	park	4.38 ☼
"	R3532-18S	Screw, oversize	1/4"-28	cad	4.38 ☼
"	R3532-18SC	Screw, oversize	1/4"-28	chrome	4.38 ☼
"	R3532-18SNI	Screw, oversize	1/4"-28	Nickle	4.38 ☼
E.	R3533-18P	Washer		park	2.00 ☼
"	R3533-18	Washer		cad	2.00 ☼
"	R3533-18C	Washer		chrome	2.81 ☼
"	R3533-18NI	Washer		Nickle	2.00 ☼
"	R3533-18SP	Washer, oversize screw		park	2.00 ☼
"	R3533-18S	Washer, oversize screw		cad	2.00 ☼
"	R3533-18SC	Washer, oversize screw		chrome	2.25 ☼
"	R3533-18SNI	Washer, oversize screw		Nickle	2.00 ☼
F.	3534-34	Paper washer	'34-'36		1.50 ☼
"	R3534-34	Paper washer	'34-'36		0.50 ☼

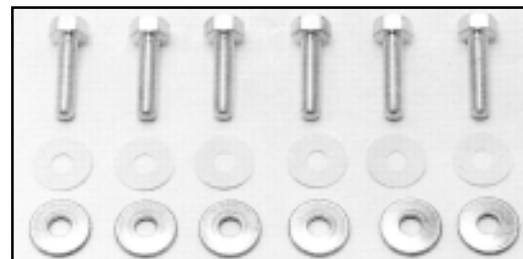

C8822-18	Set of 6	7/32"-32	cad	36.25 ☼
C8821-18	Set of 6	7/32"-32	Nickle	36.88 ☼
C2814-18	Set of 6	7/32"-32	park	35.31 ☼
C8822-18os	Set of 6	oversize 1/4"-28	cad	36.25 ☼
C8821-18os	Set of 6	oversize 1/4"-28	Nickle	36.88 ☼
C2817-18	Set of 6	oversize 1/4"-28	park	35.31 ☼



tap160-001	Tap, standard screw	7/32"-32	n.a. ☼
M1423T	Tap, oversize screw	1/4"-28	n.a. ☼
tap160-003	Tap, oversize screw	1/4"-32	n.a. ☼

Tool Box Parts

3464-26	Tool box key			8.00	☺
R3475-31A	Bolt, bracket	park	'31-'34	12.50	☺
R3477-31	Spacer, bracket bolt	park	'31-'34	7.19	☺
R0136P	Nut, bracket bolt	park	'31-'34	1.63	☺
R3805-30AP	Screw, tool box	park	'35-'36	5.00	☺
R3805-30A	Screw, tool box	cad	'35-'36	5.00	☺
R3478-35P	Washer, screw	park	'35-'36	2.50	☺
R3478-35	Washer, screw	cad	'35-'36	2.50	☺
C2456-10	Mounting kit	park	'31-'34	46.88	☺



Oil & Petrol Lines

Lines and Parts

	R3571-30	Oil line, mechanical feed '30-'33	cad	n.a. ✖
	R3571-34	Oil line, mechanical feed '34-'36	cad	n.a. ✖
	R3572-30	Oil line, hand pump '30-'36	cad	n.a. ✖
<hr/>				
	R3606-32	Petrol line (use with petrol filter)'32-'36	cad	n.a. ✖
<hr/>				
E.	R3577-15P	Nipple, oil line	park	5.00 ✖
"	R3577-15	Nipple, oil line	cad	5.00 ✖
"	R3577-15C	Nipple, oil line	chrome	6.25 ✖
F.	R3581-15	Flare nut, oil line	cad	5.50 ✖
"	R3581-15E	Flare nut, oil line early type	cad	6.35 ✖
G.	R0140	Nut	cad	3.75 ✖
H.	R3615-15	Nipple	cad	5.50 ✖
<hr/>				
J.	R3612-09	Nut, carburetor end	'30-'31	5.00 ✖
K.	R3617-15	Nipple, carburetor end (models without filter)	'30-'31	5.50 ✖
<hr/>				
L.	R3585-15	Petrol line tee only (use for repairs or to make lines yourself)	cad	n.a. ✖
M.	R3583-15	Cap, oil tank nipple	cad	2.19 ✖

Use on oil tank and oil pump when lines are disconnected, to prevent leakage or contamination during storage.

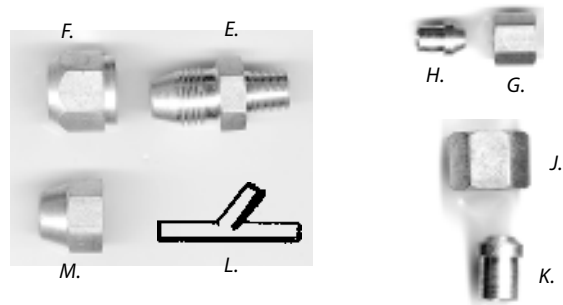
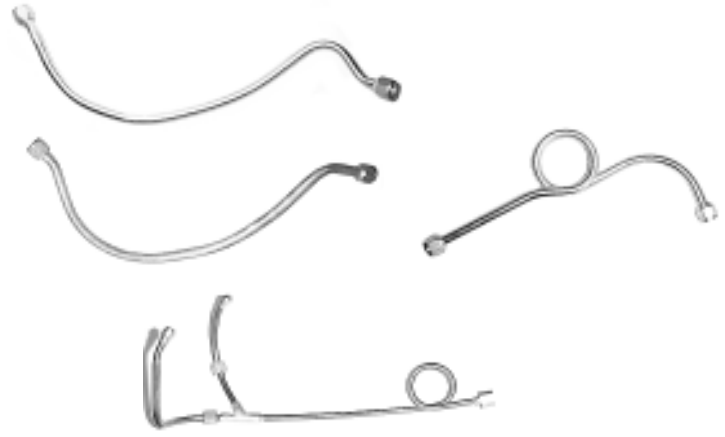

	M1902	tap	1/8-27NPT	n.a.
For rethreading threads for oil line nipple 3577-15 and for petrol valves 3601-16 in tank.				

Petrol Filter, '32-'36

	R3623-32	Petrol filter	Nickle with brass cap	93.75 ✖
Complete filter includes screen, corks, and diamond style brass cap.				
	R3627-32	Screen, with corks		20.00 ✖
	3629-31	Cap, diamond knurl style	genuine	24.00 ✖
	R3629-31	Cap, diamond knurl style	brass	18.75 ✖
	3633-32	Washer, cork		2.00 ✖
	R3633-32	Washer, cork		1.13 ✖
	R3612-09	Nut only	cad	5.00 ✖
	R3617-15	Nipple only, for repairs	cad	5.50 ✖
<hr/>				
	C3334-1	Flex hose nipple, use on filter and valves		9.81 ✖



Front Fender

R0308	Rivet	3/16" x 9/16" round head (braces to clips)		0.35 ☺
0314	Rivet	3/16" x 3/8" truss head (fenders to braces)		1.00 ☺
R3749-30P	Screw, fender to fork	park		6.00 ☺
R3749-30	Screw, fender to fork	cad		6.00 ☺
R3749-30C	Screw, fender to fork	chrome		7.00 ☺
R0259P	Lockwasher	park		0.25 ☺
R0259	Lockwasher	zinc		0.25 ☺
R0259C	Lockwasher	chrome		0.38 ☺
R0117P	Nut	park		1.19 ☺
R0117M	Nut	cad		1.25 ☺
R0117C	Nut	chrome		0.94 ☺
R0117NI	Nut	Nickle		1.35 ☺
3732-34	Brace lock, left	'34-'36 park		9.00 ☺
R3732-34	Brace lock, left	'34-'36 park		6.88 ☺
3732-34A	Brace lock, right	'34-'36 park		9.00 ☺
R3732-34A	Brace lock, right	'34-'36 park		6.88 ☺

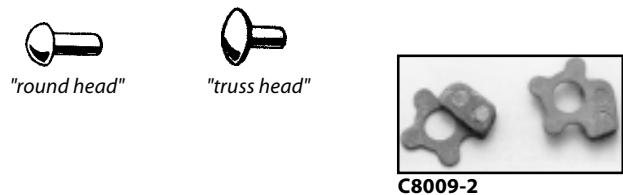

Front fender mounting kits

includes fender to fork screws and lower brace locks and nuts

C9680-6	Mounting kit	'34-'36 parkerized		22.50 ☺
C8203-6	Mounting kit	'34-'36 cad plated		22.50 ☺
C9742-6	Mounting kit	'34-'36 chrome plated		26.25 ☺
C8009-2	Locks only	'34-'36 parkerized		13.75 ☺



C9786-11 Fender lamp wire kit '34-'36 32.50 ☺
Steel tube, clamps, nuts, connectors, wire and loom will secure wire to fender as original.

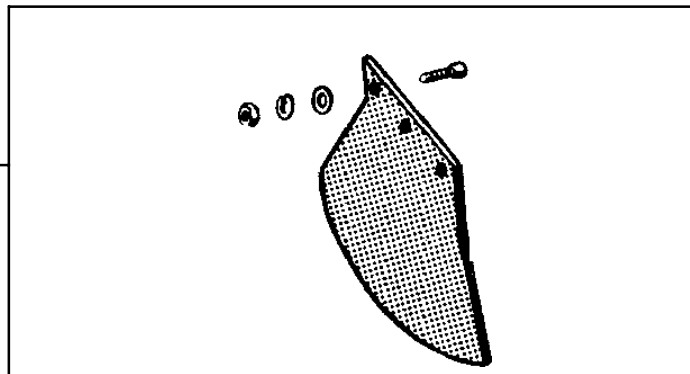

R3757-26 Mudflap rubber black n.a. ☺
Reinforced rubber as original. Includes parkerized hardware.

R033P	Screw, mudflap	park		0.63 ☺
R033	Screw, mudflap	cad		0.69 ☺
R033C	Screw, mudflap	chrome		0.85 ☺
R0205P	Washer	park		0.38 ☺
R0254P	Lockwasher	park		0.25 ☺
R0254	Lockwasher	zinc		0.20 ☺
R0254C	Lockwasher	chrome		0.38 ☺
R0104P	Nut	park		0.50 ☺
R0104Z	Nut	zinc		0.40 ☺
R0104C	Nut	chrome		0.75 ☺

Rear Fender

3741-34	Rear fender end brace bracket	'34-'36		17.00 ☺
R0308	Rivet	3/16" x 9/16" round head (braces to clips)		0.35 ☺
0314	Rivet	3/16" x 3/8" truss head (fenders to braces)		1.00 ☺
R3743-23	Bolt, rear end with nut	park		7.50 ☺
R0117P	Nut only	park		1.19 ☺
R0117M	Nut only	cad		1.25 ☺
R0117C	Nut only	chrome		0.94 ☺
R0117NI	Nut only	Nickle		1.35 ☺
R0214P	Washer	park		0.50 ☺
R0214	Washer	cad		0.50 ☺
R0214C	Washer	chrome		0.40 ☺
R0259P	Lockwasher	park		0.25 ☺
R0259	Lockwasher	zinc		0.25 ☺
R0259C	Lockwasher	chrome		0.38 ☺
C2460-2	Bolt kit (2)	park		15.00 ☺

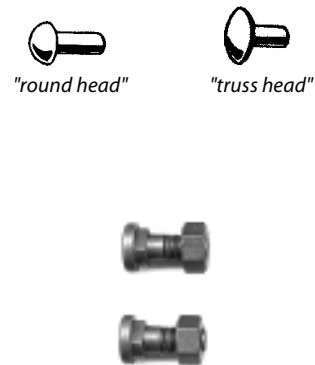

Chainguard / Axle

A.	R3805-30AP	Screw, front chain guard back	park	5.00	⊛
"	R3805-30A	Screw, front chain guard back	cad	5.00	⊛
B.	R3805-30Bzinc	Lock, front chain guard screw	zinc	1.70	
	3805-32D	Washer, plug	'32-'36	1.00	⊛
C.	R3811-29	Cover, chain inspection	black	n.a.	
"	R3811-29C	Cover, chain inspection	chrome	8.00	
D.	R048AP	Screw, inspection cover	park	0.94	⊛
"	R048A	Screw, inspection cover	cad	1.00	⊛
"	R048AC	Screw, inspection cover	chrome	1.25	⊛
	R3813-30P	Screw, chain guard/gear box	'30-'35	1.88	⊛
	C3004-9	Inner/outer primary mounting kit		30.00	⊛



Rear Axle Parts

F.	R3957-30P	Nut, rear axle, with nipple	park	14.38	⊛
"	R3957-30C	Nut, rear axle, with nipple	chrome	15.63	⊛
	R0340	Grease nipple, Alemite	Nickle	3.75	⊛
G.	R3958-32P	Lockwasher	park	6.88	⊛
"	R3958-32	Lockwasher	cad	6.88	⊛
"	R3958-32C	Lockwasher	chrome	7.50	⊛
H.	R3961-30P	Collar, sleeve	park	6.25	⊛
"	R3961-30	Collar, sleeve	cad	6.25	⊛
"	R3961-30C	Collar, sleeve	chrome	8.75	⊛
J.	3963-30	Nut, axle sleeve	park	17.00	⊛
"	R3963-30P	Nut, axle sleeve	park	13.75	⊛
"	R3963-30	Nut, axle sleeve	cad	13.75	⊛
"	R3963-30C	Nut, axle sleeve	chrome	15.63	⊛

Rear Axle Nut Kits

Include nuts, collar and lockwasher.

C9611-5	Axle nut kit	park	30.63	⊛
C9610-5	Axle nut kit	chrome	41.25	⊛

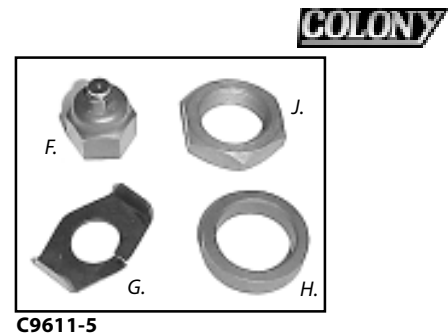

Rear Chain Adjusters

C2069-5	Kit, two screws and spacer	cad/park	25.00	⊛
R2826-30	Screw, rear axle adjusting	cad	12.50	⊛
R3011-30	Spacer only	park	3.75	⊛

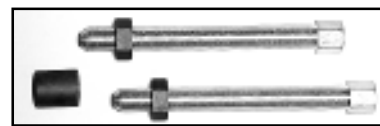

C2069-5

Front Axle Parts

R4178-30P	Nut, front axle	park	10.00	⊛
R4178-30C	Nut, front axle	chrome	11.25	⊛
R4184-30P	Nut, axle sleeve	park	7.50	⊛
R4184-30	Nut, axle sleeve	cad	8.13	⊛
R4184-30C	Nut, axle sleeve	chrome	10.00	⊛
C9406-3	Kit, axle and sleeve nut	park	21.88	⊛
C9405-3	Kit, axle and sleeve nut	chrome	30.00	⊛



C9406-3

COLONY

Rear Brake Parts

A.	R4055-31	Spring washer		'31-'36	2.25 ☺
B.	R4059-35	Pivot stud plate	zinc	'35-'36	5.00
"	R4059-35P	Pivot stud plate	park	'35-'36	7.00
C.	R2634-30AP	Nut, pivot stud	park	'35-'36	2.50 ☺
"	R2634-30A	Nut, pivot stud	cad	'35-'36	2.50 ☺
"	R2634-30AC	Nut, pivot stud	chrome	'35-'36	3.44 ☺

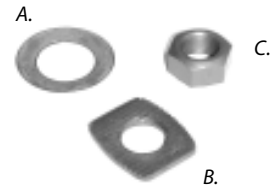

Rear Brake Control Parts

D.	R4063-30	Brake rod, front	park		n.a. ☺
E.	R4065-30	Brake rod, rear	park		35.00 ☺
	R0117P	Nut, brake rod	park		1.19 ☺
	R0117M	Nut, brake rod	cad		1.25 ☺
	R0117C	Nut, brake rod	chrome		0.94 ☺
	R0117NI	Nut, brake rod	Nickle		1.35 ☺
F.	R4067-30	Clevis, long	park	'35-'52	n.a. ☺
"	R4067-30C	Clevis, long	chrome	'35-'52	n.a. ☺
Above "long" clevises are exact replacement parts					
"	R4067-51C	Clevis, short (10 cm)	chrome	'35-'52	10.00
G.	R2422-30A	Clevis, front rod	park		n.a. ☺
"	R2422-30AC	Clevis, front rod	chrome		6.00
H.	2423-30	Clevis pin			1.00 ☺
	R0207P	Washer, clevis pin	park		0.44 ☺
	R0212P	Washer, brake rod	park		0.50 ☺
	R0290P	Cotter pin	park		0.19 ☺
	R0290	Cotter pin	zinc		0.15 ☺
K.	R2964-26	Spring, brake lever	black		6.00 ☺
"	R2964-26P	Spring, brake lever	park		6.00 ☺
"	R2964-26C	Spring, brake lever	chrome		7.50 ☺

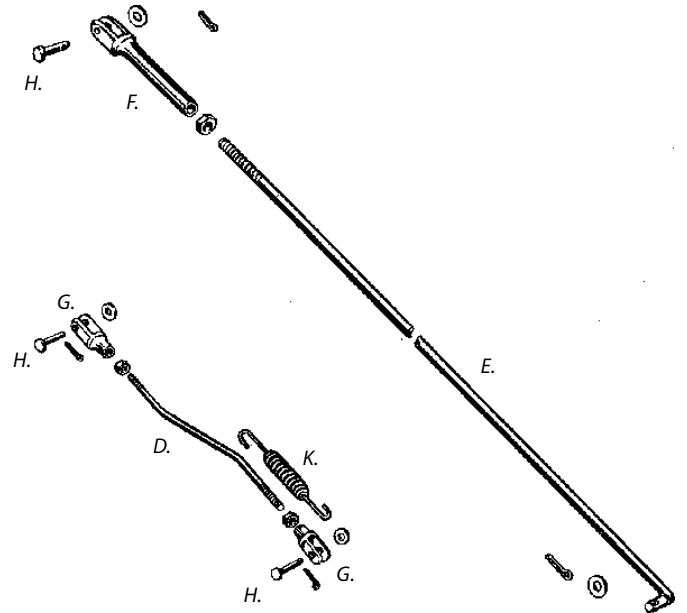

L.	R4075-31	Cross-over shaft		'31-'36	38.00
M.	R4075-31A	Bushing		'31-'36	10.00 ☺
	C2712-1	Bushing installing tool			13.13 ☺
O.	R4078-30	Lockwasher park		late '30-'36	4.38 ☺
P.	R4079-26P	Nut	park		5.94 ☺
	R4079-26	Nut	cad		5.94 ☺

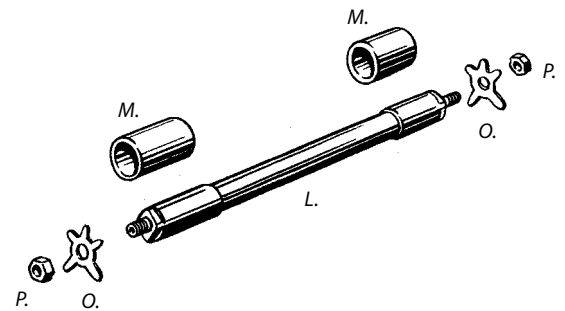
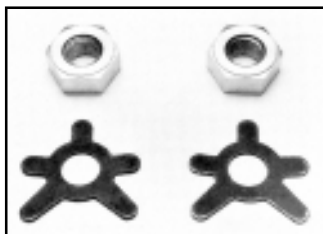

C9677-4	Nut and washer kit	park	19.38 ☺
C7820-4	Nut and washer kit	cad	20.00 ☺
C8409-4	Nut and washer kit	chrome	21.88 ☺

Front Brake

Front Brake Parts

	4112-35	Set brake shoes with linings '31-'36	n.a. ✖
B.	R4118-35	Pivot stud, front brake '35-'36	19.38 ✖
C.	R4119-35	Plate, pivot stud zinc	5.00
D.	R0261P	Lockwasher park	0.25 ✖
"	R0261	Lockwasher zinc	0.25 ✖
"	R0261C	Lockwasher chrome	0.38 ✖
E.	R0127P	Nut, pivot stud park	1.50 ✖
"	R0127	Nut, pivot stud cad	1.63 ✖
"	R0127C	Nut, pivot stud chrome	1.06 ✖
"	R0127NI	Nut, pivot stud Nickle	1.60 ✖
F.	4124-31	Stud, brake operating '31-'36	n.a.
	R4124-31AP	Grease nipple, operating stud '31-'36	6.25 ✖
G.	R4055-35	Washer, operating stud	1.80
H.	R4125-28A	Spring, front brake shoe	3.00
"	R4125-28A.10pack	10 Springs, brake shoe	24.50

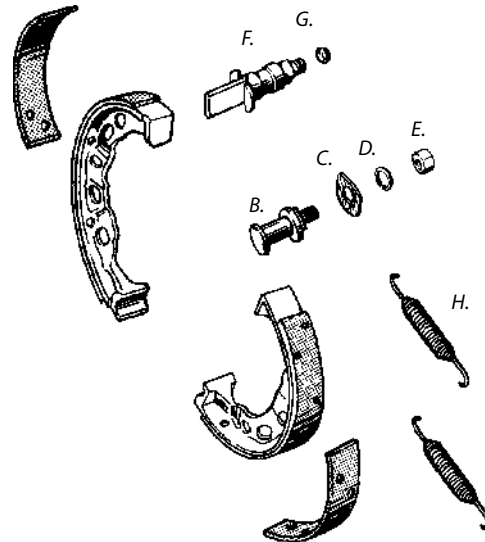

Brake Shackle Parts

J.	4131-28	Bushing, brake shackle	7.00 ✖
	C2959-2	Bushing installation tool	25.00 ✖
K.	R4133-31	Stud, brake shackle	38.13 ✖
L.	R0128P	Castle nut park	2.00 ✖
"	R0128	Castle nut cad	2.13 ✖
"	R0128C	Castle nut chrome	2.31 ✖
"	R0128NI	Castle nut Nickle	2.00 ✖
M.	4137-30	Stud, shackle band	8.00 ✖
O.	R0223P	Washer park	1.13 ✖
"	R0223	Washer cad	1.13 ✖
"	R0223C	Washer chrome	1.20 ✖
P.	R0261P	Lockwasher park	0.25 ✖
"	R0261	Lockwasher zinc	0.25 ✖
"	R0261C	Lockwasher chrome	0.38 ✖
R.	0129	Nut park	1.50 ✖
"	R0129P	Nut park	1.44 ✖
"	R0129	Nut cad	1.56 ✖
"	R0129C	Nut chrome	1.75 ✖

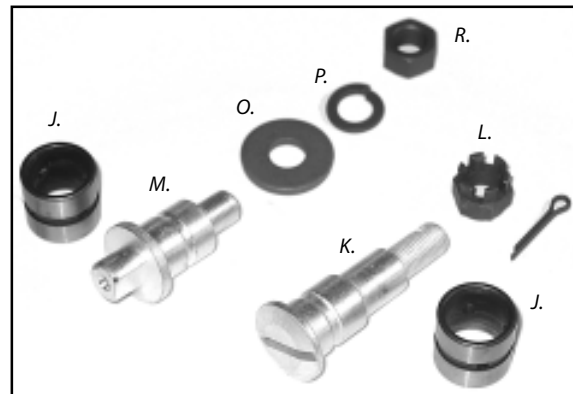

C2298-10

	C2298-10	Rebuild kit	96.88 ✖
--	-----------------	-------------	---------

Brake Cables

	R4142-30	Brake coil coupling (oiler) cad	32.50 ✖
	4143-30B	Short coil, lever to oiler (cotton)	n.a. ✖
	R3334-12	Outer cable, Nickle 130 cm	n.a.
	R4143-30	Outer cable, plastic covered 130 cm	37.50 ✖
	R4143-39	Outer cable, cotton braided 130 cm	n.a.
	R4144-30P	Ferrule, cotton braided cables park	5.50 ✖
	R4144-30	Ferrule, cotton braided cables cad	5.50 ✖
	R4144-30NI	Ferrule, cotton braided cables nickle	5.50 ✖
	R4144-30AP	End nut park	9.38 ✖
	C3324-2	End nut with felt seal park	11.25 ✖
	C3299-2	End nut with felt seal cad	11.25 ✖
	4145-28	Wire, control (inner cable) 150 cm	n.a.
	R4145-28	Wire, control (inner cable) 160 cm	7.50 ✖



R4142-30

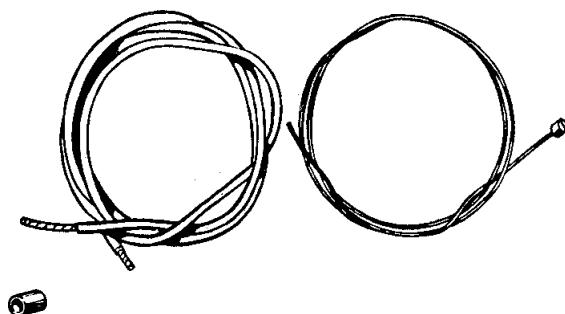

Front Brake Control Parts

A.	4154-28	Screw, bracket clamp	park	3.00 ☺
B.	R032P	Screw, bracket clamp	park	0.63 ☺
"	R032	Screw, bracket clamp	cad	0.69 ☺
"	R032C	Screw, bracket clamp	chrome	0.81 ☺

Note: Use one 4154-28 special screw and one 032 standard screw.

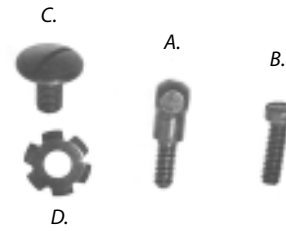

C.	4156-28	Screw, hand lever	park	10.00 ☺
D.	4157-28	Spring washer, screw		4.00 ☺

E.	4160-28	Clamp, coil to handlebar	black	19.00 ☺
"	R4160-28	Clamp, with screw and nut	park	13.75 ☺

F.	R4162-30	Clamp, coil to shackle stud	park	6.25 ☺
	R4163-30	Clamp, coil to fork	park	25.00 ☺

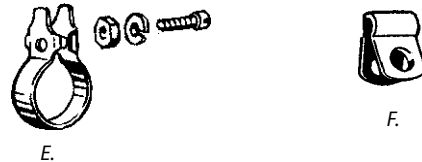

	053	Screw	park	3.00 ☺
	R053P	Screw	park	1.56 ☺
	R053C	Screw	chrome	1.80 ☺
	R0256P	Lockwasher	park	0.25 ☺
	R0256	Lockwasher	zinc	0.25 ☺
	R0256C	Lockwasher	chrome	0.38 ☺
	0108	Nut	park	1.50 ☺
	R0108P	Nut	park	1.13 ☺
	R0108M	Nut	cad	1.19 ☺
	R0108C	Nut	chrome	0.88 ☺
	R0108NI	Nut	Nickle	1.56 ☺

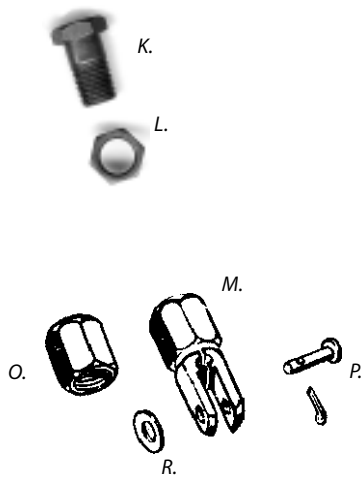

K.	R4165-28P	Adjusting screw	park	10.00 ☺
"	R4165-28	Adjusting screw	cad	15.00 ☺
"	R4165-28C	Adjusting screw	chrome	15.69 ☺
L.	R4166-28P	Nut	park	1.75 ☺
"	R4166-28	Nut	cad	1.88 ☺
"	R4166-28C	Nut	chrome	2.50 ☺
M.	4170-28	Connection, with nut	park	14.00 ☺
"	4170-28.2pack	Genuine bag with two connections		30.00 ☺
O.	4171-29	Nut only	park	3.00 ☺
P.	4069-26	Pin		2.00 ☺
R.	0207	Washer	park	1.00 ☺
	R0290P	Cotter pin	park	0.19
	R0290	Cotter pin	zinc	0.15

Electrical

Battery Box Parts

R4409-26P	Wing nut, battery cover	park	1.50	✪
R4409-26	Wing nut, battery cover	cad	1.50	✪
R4409-26C	Wing nut, battery cover	chrome	2.50	✪
4433-23	Screw, terminal	cad	n.a.	✪
4434-23	Nut, terminal screw	cad	1.70	✪
4433-23A	Felt, terminal		1.00	✪
R4435-23	Set screws with felts	cad	17.50	✪
R066P	Bolt, front mounting	park	2.19	✪
R066Z	Bolt, front mounting	zinc	0.75	✪
R066C	Bolt, front mounting	chrome	1.30	✪
069	Bolt, rear upper mounting	park	1.50	✪
R061P	Bolt, rear lower mounting	park	1.63	✪
R061	Bolt, rear lower mounting	cad	1.69	✪
R061C	Bolt, rear lower mounting	chrome	1.40	✪
R0117P	Nut, mounting bolts	park	1.19	✪
R0117M	Nut, mounting bolts	cad	1.25	✪
R0117C	Nut, mounting bolts	chrome	0.94	✪
R0117NI	Nut, mounting bolts	Nickle	1.35	✪
C3362-1	Upper bolt lock plate 4417-30	park	19.38	✪

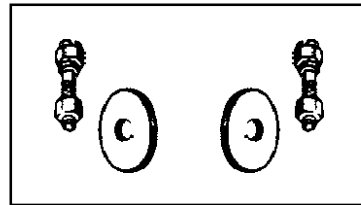

R4435-23

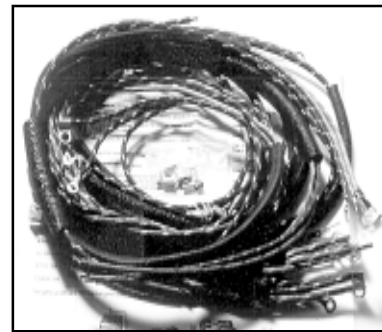

R4735-30

Wiring Kit

Includes all low tension wiring, loom and original type terminals.

R4735-30	Complete wiring kit	'30-'36	137.50	✪
R4732-34	Sidecar taillight wiring kit	'34-'36	n.a.	✪

Wire

fabric as used on '69 and earlier models

R4712-15A	black / white tracer	1 meter	2.00	✪
R4712-15B	green / white tracer	1 meter	2.00	✪
R4712-15C	yellow / black tracer	1 meter	2.00	✪
R4712-15D	red / white tracer	1 meter	2.00	✪
R4712-15E	green	1 meter	2.00	✪
R4712-15F	red	1 meter	2.00	✪
R4712-15G	black / red tracer	1 meter	2.00	✪
R4712-15H	gray / black tracer	1 meter	2.00	✪
R4712-15K	red / black tracer	1 meter	2.00	✪
R4712-15M	blue / white tracer	1 meter	2.00	✪
R4712-15P	red / yellow tracer	1 meter	2.00	✪
R4712-15R	black	1 meter	2.00	✪
R4712-15S	white / blue tracer	1 meter	2.00	✪
R4712-15T	light blue / black tracer	1 meter	2.00	✪
R4712-15U	yellow	1 meter	2.00	✪



R4506-29AP	Switch box fastening bolt	park	6.25	✪
R4506-29A	Switch box fastening bolt	gray Nickle	8.44	✪
R4521-26	Key, switch		6.50	✪



Wire loom

fabric as used on '69 and earlier models

R4711-45A	I.D. 3/16"	4,7 mm	1 meter	3.50	✪
R4711-45B	I.D. 1/4"	6,3 mm	1 meter	3.50	✪
R4711-45C	I.D. 5/16"	7,9 mm	1 meter	3.50	✪
R4711-45D	I.D. 3/8"	9,5 mm	1 meter	4.00	✪
R4711-45E	I.D. 1/2"	12,7 mm	1 meter	n.a.	✪



Terminals

"Early style" terminals:

R4715-18	Terminal, round solder type	'18-'37	n.a.	✪
1614-18	Terminal and eyelet	'18-'47	3.00	✪



"Modern style" terminals:

R1520-40	Flag terminal	14-16 gauge, #10 eye	1.00	✪
R1520-41	Ring terminal	14-16 gauge, # 6 eye	0.25	✪
R1520-42	Ring terminal	14-16 gauge, #10 eye	0.25	✪
R1520-43	Flag terminal	14-16 gauge, #12 eye	0.50	✪



Horn Switch

B.	4762-26	Button		5.00	⊗
C.	4764-26	Spring		2.00	⊗
D.	4766-26	Insulation		5.00	⊗
F.	4776-26	Washer, horn spring		8.00	⊗
	R018P	Screw	park	0.56	⊗
	R018	Screw	cad	0.63	⊗
	R018C	Screw	chrome	0.75	⊗

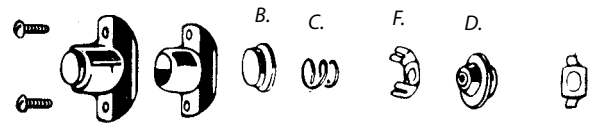

Headlight Dimmer Switch

H.	4760-29C	Switch	chrome	n.a.	⊗
"	4760-29N	Switch	green	75.00	⊗
J.	4764-29	Lever		n.a.	⊗
L.	4768-29C	Housing	chrome	n.a.	⊗
"	4768-29N	Housing	green	14.00	⊗
M.	4770-29	Pin, contact (2 position)		4.00	⊗
"	4770-38A	Pin, contact (3 position)		5.00	⊗
N.	4771-29	Spring, pin		2.50	⊗
O.	4776-29	Block		n.a.	⊗
	R018P	Screw	park	0.56	⊗
	R018	Screw	cad	0.63	⊗
	R018C	Screw	chrome	0.75	⊗

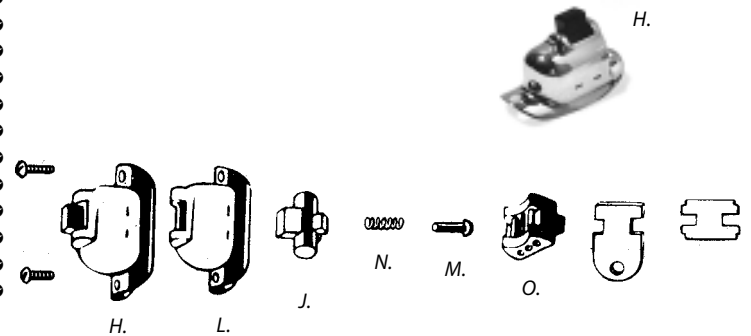

Wire Clamps

R1602-30	Clamp	park	14.38	⊗
R4726-24	Clamp	park	21.25	⊗
R4726-31	Wire clip	park	6.88	⊗
R4728-25	Clamp	park	15.00	⊗
R4727-23	Clamp	park	15.00	⊗
R4727-30	Clamp	park	15.00	⊗
R4730-30	Clamp	park	25.00	⊗
R4730-30A	Clamp	park	15.00	⊗

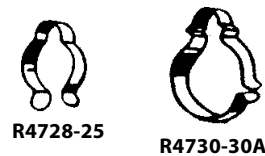

Relay

Electronic, use with 32E three-brush generator. (V-Tronic)

R4785-26	Relay, without cover		'30-'36	47.00
R4786-26DR	Cover	black	'30-'36	23.50
R4786-26DRC	Cover	chrome	'30-'36	25.00

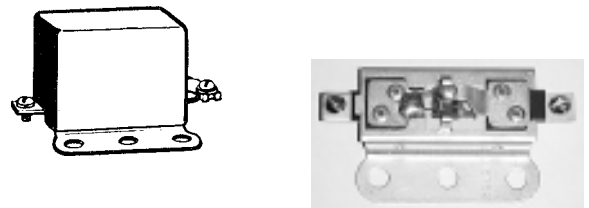

Horn Mounting Parts

V.	R4861-29	Spring plate, horn bracket		8.25	⊗
W.	R4862-29	Spring plate, straight		6.75	⊗
X.	R4862-31	Spring plate, curved	'31-'36	8.25	⊗
Y.	R4884-26	Screw, round head, short (front cover)	cad	6.00	⊗
Z.	R4884-31	Screw, round head, long (plate mounting)	cad	n.a.	⊗
	4829-31	Fibre, terminal screw	'31-'36	1.00	⊗
	R4863-31KIT	Horn mounting kit	'31-'36	110.00	⊗

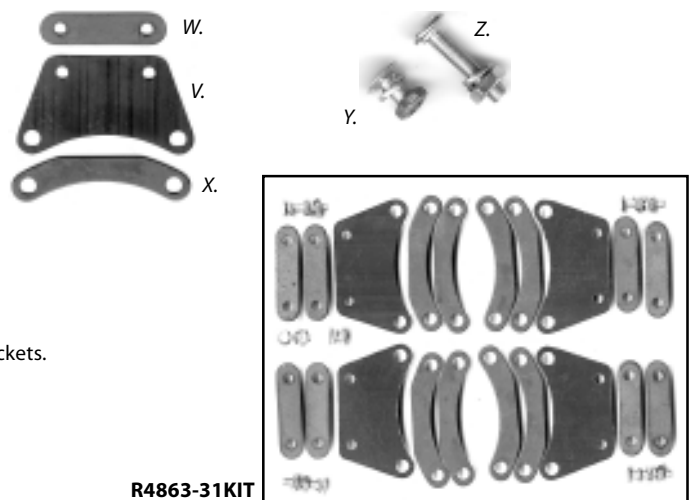

Kit includes all plates, screws and nuts to mount horn to left and right brackets.

Headlight / Taillight

'35-'36 Headlamp and Parts

A.	R4901-35	Headlamp, black/ chrome ring	6 Volt	75.00
"	R4901-35C	Headlamp, chrome	6 Volt	80.00
"	R4901-35C12V	Headlamp, chrome	12 Volt	82.00
B.	R4906-35	Headlamp lens "Cyclaray"		18.00
"	R4906-35.5pack	5 Headlamp lenses		75.00
	R4910-35	Retainer clip, lens		8.75 ☼
	R4912-35	Gasket, lens		12.00 ☼
C.	4914-35N	Door (bezel) green		37.50 ☼
"	R4914-35C	Door (bezel) chrome		19.00
	4915-35	Lug, door		1.00 ☼
D.	R4918-35P	Screw, door fastening park		1.00 ☼
"	R4918-35	Screw, door fastening cad		1.06 ☼
"	R4918-35C	Screw, door fastening chrome		1.50 ☼
E.	R4922-35kit	Reflector, with socket and wiring		22.00
F.	R4925-35	Bulb, headlamp 6 Volt 35/35W		5.00
"	R4925-54	Bulb, headlamp 6 Volt 50/50W		5.00
		(higher than standard wattage, must be used with 2-brush generator to prevent drainage of the battery)		
"	R4925-3512V	Bulb, headlamp 12 Volt		7.00
H.	4938-35	Block, terminal, incl. 2 screws		27.00 ☼
I.	4940-35	Screw, terminal 8-32		1.50 ☼
K.	4941-35	Screw, terminal 10-32		1.00 ☼
	R0352	Lockwasher zinc		0.20 ☼
	R0356	Lockwasher zinc		0.20 ☼
L.	4905-29	Bolt, headlamp fastening		10.00 ☼
M.	R4971-38AP	Washer, head lamp park		4.56 ☼
"	R4971-38A	Washer, head lamp cad		4.56 ☼
O.	0134	Nut, headlamp fastening park		2.00 ☼
"	R0134P	Nut, headlamp fastening park		1.69 ☼
"	R0134	Nut, headlamp fastening cad		1.81 ☼
"	R0134C	Nut, headlamp fastening chrome		3.13 ☼
"	R0134NI	Nut, headlamp fastening Nickle		2.50 ☼
	R0265P	Lockwasher park		0.69 ☼
	R0265	Lockwasher zinc		0.75 ☼
	R0265C	Lockwasher chrome		0.94 ☼

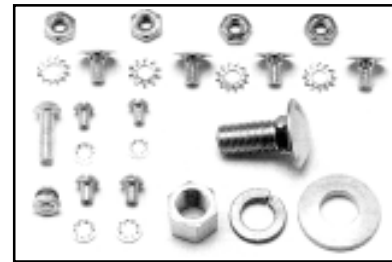
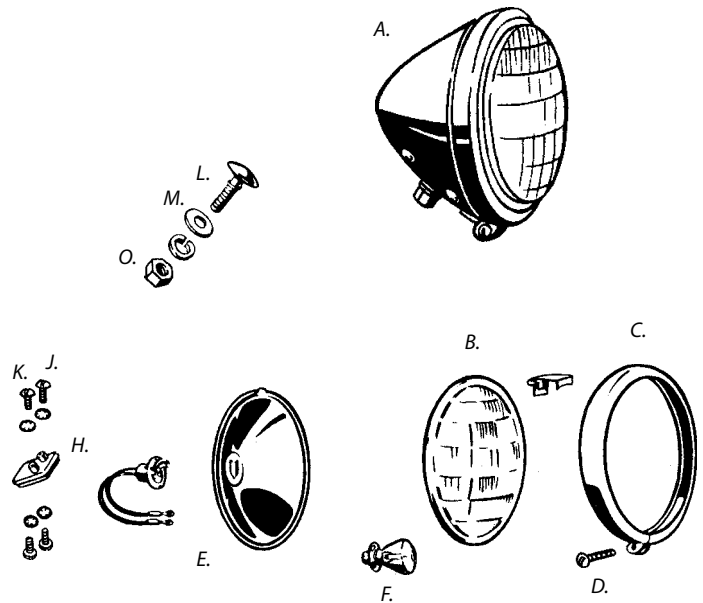

C8943-27 Headlamp restoration kit 32.50 ☼
All parts to restore and mount headlamp, includes special bolts to replace rivets.

R4947-35 Special bolt only, with nut cad n.a. ☼

R3475-31A	Bolt, lamp bracket park	'31-'34	12.50 ☼
R3475-31	Bolt, lamp bracket park	'35-'36	12.50 ☼
R3477-31	Spacer, bracket bolt park	'31-'34	7.19 ☼
R0136P	Nut, bracket bolt park	'31-'36	1.63 ☼



Headlamp Bracket Mounting Kits

C2456-10	Mounting kit park	'31-'34	46.88 ☼
C2457-8	Mounting kit park	'35-'36	24.38 ☼
C2458-8	Mounting kit chrome	'35-'36	31.25 ☼

Taillight Lenses

R5054-20	Red lens	'20-'33 models	n.a. ☼
R5054-34	Red lens	'34-'38 models	38.50 ☼
R5065-25	White lens	'25-'38 models	37.00 ☼

R5058-34	Bulb 6 Volt	'34-'36 tail/stoplight	6.00 ☼
R5058-47	Bulb 6 Volt	('47-up fitting)	2.00



R11350-34BL	Mirror, short model	black	n.a. ☼
R11350-34XL	Mirror, bent stem	black	n.a. ☼
R11350-41M	Mirror with extension	black	n.a. ☼
R11350-41MA	Extension only		n.a. ☼
R11350-41MH	Replacement mirror head only		n.a. ☼
R11350-42C	Mirror, with clamp	chrome	10.00
91870-34T	Mirror, with clamp "Harley-Davidson"		65.00

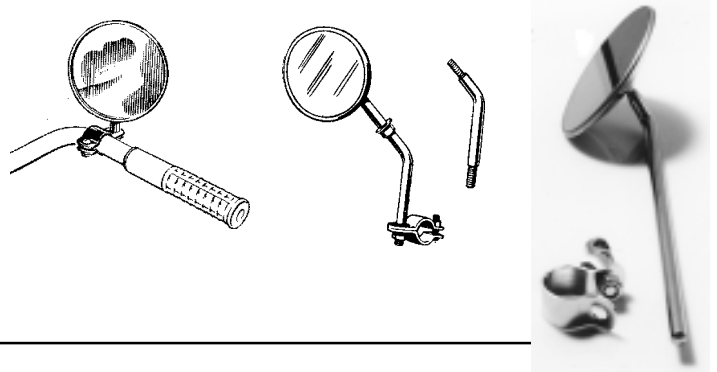

R11787-XC	Set of saddlebag plates to mount saddlebags directly to fender, 4 hole style	chrome	n.a. ☼
C8205-8	Mounting kit, 8 studs with acorn nuts		33.75 ☼

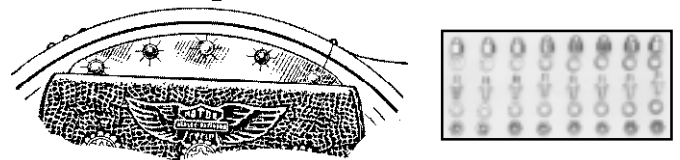

C3240-4	Fender lamp gasket and screw kit '35-'48		18.75 ☼
C9786-11	Front fender lamp wire kit		32.50 ☼

Steel tube, clamps, nuts, connectors, wire and loom will secure wire to fender as original on '35-'47 models.

4724-15cad	Small tubing clamp only	cad	9.00 ☼
R4724-15	Small tubing clamp only	park	5.00 ☼

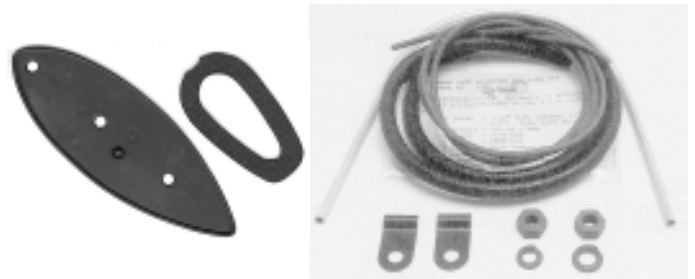

Jiffy stand parts

R13202-30	Spring, jiffy leg		5.50
R13202-30P	Spring, jiffy leg	park	5.50
R13202-30B	Spring, jiffy leg	black	n.a.
R13205-30	Bushing, jiffy leg		12.00
R13205-30os	Bushing, jiffy leg	oversize	n.a.
1723-30	U-bolt, with nuts	park	12.50 ☼
0109	Nut	park	2.00 ☼
0109C	Nut	chrome	2.30 ☼
R0229P	Washer	park	0.63 ☼
R0133P	Nut	park	1.63 ☼
R0133	Nut	cad	1.69 ☼
R0133C	Nut	chrome	1.88 ☼



Buddy Seat Parts

13314-33	Bolt, clip 1-3/8"	park	'33-'36	n.a. ☼
13316-33	Bolt, clip 7/8"	park	'33-'36	6.00 ☼
R4409-26	Wing nut, clip bolt	cad	'33-'36	1.50 ☼
13322-33	Spring, auxiliary	black	'33-'36	25.00 ☼
13322-33N	Spring, auxiliary	green	'33-'36	20.00 ☼
R13322-33C	Spring, auxiliary	chrome	'33-'36	n.a.
2641-30	Nut, spring	park	'33-'36	2.00 ☼
R2641-30	Nut, spring	cad	'33-'36	2.50 ☼
2641-30C	Nut, spring	chrome	'33-'36	3.00 ☼
13331-33N	Bracket, aux. springs		'33-'36	n.a.
13340-33	Yoke hook, springs	park	'33-'36	n.a.
069	Bolt, aux. spring bolt	park	'33-'36	1.50 ☼

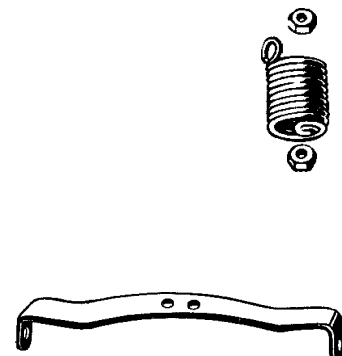

Ride Control / Bearings

Ride Control Parts '33-'36

A.	R13430-33	Friction disc cup	zinc	n.a. ☼
"	R13430-33C	Friction disc cup	chrome	7.00 ☼
B.	R13431-33	Friction disc		n.a. ☼
C.	13437-33	Spring washer	park	14.00 ☼
"	R13437-33	Spring washer	park	7.00 ☼
D.	R13440-33	Adjusting wheel	bare	n.a. ☼
"	R13440-33C	Adjusting wheel	chrome	23.00 ☼
E.	13442-33	Spring clip	park	18.00 ☼
"	R13442-33	Spring clip	park	n.a. ☼
F.	13444-33	Wheel collar	park	13.00 ☼
"	R13444-33P	Wheel collar	park	7.00 ☼
"	R13444-33	Wheel collar	cad	7.00 ☼
"	R13444-33C	Wheel collar	chrome	7.50 ☼
G.	R13454-33	Rubber bushing		9.38 ☼
	R0231P	Washer, plate stud	park	1.25 ☼
	0129	Nut, side plate stud	park	1.50 ☼
	R0129P	Nut, side plate stud	park	1.44 ☼
	R0129	Nut, side plate stud	cad	1.56 ☼
	R0129C	Nut, side plate stud	chrome	1.75 ☼

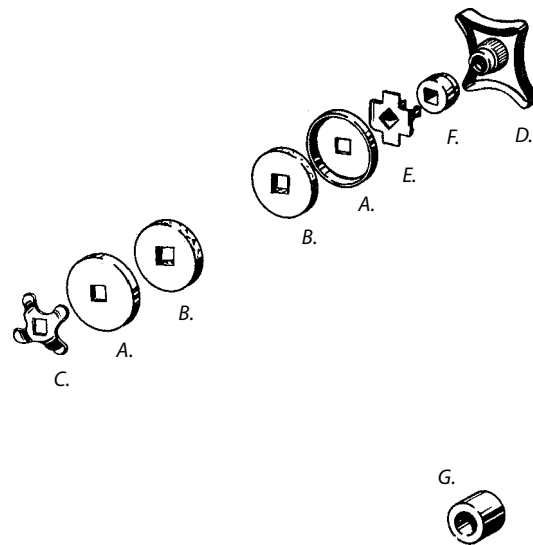

Roller Bearing Roller Guide

check website for 100-packs

Forked end connecting rod	(24)	'30-'36	
Front brake hub	(24)	'30-'36	
Sidecar brake hub, except LE	(28)	'30-'36	
R304-15	Roller, standard	0.2498" x .360"	n.a.
R304-15D	Roller, oversize	+0.0002"	0.60
R304-15F	Roller, oversize	+0.0004"	0.60
304-15H	Roller, oversize	+0.0006"	1.00 ☼
R304-15H	Roller, oversize	+0.0006"	0.60
304-15KA	Roller, oversize	+0.0008"	1.00 ☼
R304-15KA	Roller, oversize	+0.0008"	0.60
304-15MA	Roller, oversize	+0.0010"	n.a.
Single end connecting rod	(12)	'30-'36	
Clutch sprocket	(12)	'30-'36	
R305-15	Roller, standard	0.2498" x .726"	1.00 ☼
R305-15D	Roller, oversize	+0.0002"	0.60 ☼
R305-15F	Roller, oversize	+0.0004"	0.60 ☼
R305-15H	Roller, oversize	+0.0006"	0.60 ☼
R305-15KA	Roller, oversize	+0.0008"	0.60 ☼
R305-15MA	Roller, oversize	+0.0010"	0.60 ☼
R305-15MA2	Roller, oversize	+0.0020"	0.60 ☼
Countershaft gear, standard transmission	(24)	'30-'31	
R2289-17	Roller, standard	0.2498" x .270"	n.a. ☼
R2289-17D	Roller, oversize	+0.0002"	0.50 ☼
R2289-17F	Roller, oversize	+0.0004"	0.50 ☼
R2289-17H	Roller, oversize	+0.0006"	0.50 ☼
R2289-17KA	Roller, oversize	+0.0008"	0.50 ☼
R2289-17MA	Roller, oversize	+0.0010"	0.50 ☼
R2289-17Q	Roller, undersize	-0.0002"	0.50 ☼

Left crankcase	(24)	'30-'36	
Main drive gear	(20)	'30-'36	
Interchangeable wheel hub	(28)	'30-'36	
Countershaft gear, right side	(12)	'32-'36	
R2289-25	Roller, standard	0.2498" x .490"	0.50 ☼
R9219	Roller, oversize	+0.0001"	0.50 ☼
R2289-25D	Roller, oversize	+0.0002"	0.50 ☼
R9218	Roller, oversize	+0.0003"	0.50 ☼
R2289-25F	Roller, oversize	+0.0004"	0.50 ☼
R9217	Roller, oversize	+0.0005"	0.50 ☼
R2289-25H	Roller, oversize	+0.0006"	0.50 ☼
R2289-25KA	Roller, oversize	+0.0008"	0.50 ☼
R2289-25MA	Roller, oversize	+0.0010"	0.50 ☼
R2289-25MA2	Roller, oversize	+0.0020"	0.50 ☼
Countershaft gear, left side	(21)	'32-'36	
2306-32	Roller, standard	0.152" x .625"	1.50 ☼
2306-32D	Roller, oversize	+0.0002"	1.50 ☼
2306-32F	Roller, oversize	+0.0004"	1.50 ☼
R2306-32F	Roller, oversize	+0.0004"	0.50
R2306-32H	Roller, oversize	+0.0006"	0.50
R2306-32KA	Roller, oversize	+0.0008"	0.50
R2306-32MA	Roller, oversize	+0.0010"	0.50

Feeler Gauges



MFG002 25- Blade .0015" - .035" n.a.

U.S. Pitch Gauge

M3118PG Measures number of threads per inch n.a.
Essential tool for determining all UNF/UNC and special thread sizes.



Thread Files

To restore externally damaged threads.

MTR1 Contains most popular sizes n.a.
(11, 12, 13, 14, 16, 18, 20, 24 threads per inch)

MTR2 Contains less used sizes n.a.
(9, 10, 12, 16, 20, 27, 28, 32 threads per inch)



R1080 Solid brass hammer, 48 oz. 1-1/4" head 120.00 ☺



R1081 Solid brass punch set, 4-piece 139.50 ☺
Includes 3/8", 1/2", 5/8", 3/4" punch, use 3/8" punch for setting oil pump check valve ball.



Grease Guns

- Alemite connections are used with "Alemite" nipples ('24-'37 models).
- Hydraulic connections are for use with '38-up "Zerk" grease nipples.

GG1 Grease gun, with hydraulic connection n.a.
GG3 Grease gun, with Alemite connection n.a.

Grease gun for Alemite nipples uses flexible hose.

GG4 High pressure hose only 9.50
GG6 Alemite nipple head 47.50



GG6

C2962-6 Alemite grease nipples (6) brass '24-'37 22.50
C8770-6 Alemite grease nipples (6) Nickle '24-'37 22.50

Heli-Coil® / Taps & Dies



Heli-Coil® has the most effective and universally accepted method of thread repair. Heli-Coil® inserts quickly and permanently restore stripped, worn or damaged threads to their original size and condition.

Heli-Coil® Thread Repair Kits

Individual kits come complete with a quantity of Heli-Coil® stainless steel inserts, a tap and an installation tool, order correct size drill seperately. All kits come with step-by-step instructions.



Heli-Coil® Kits, UNF-UNC

Kit	Thread	Inserts	Length	Use drill	
H5521-2	8-32	12	.246"	11/64"	56.00
H5521-3	10-24	12	.285"	13/64"	56.00
H5528-3	10-32	12	.285"	13/64"	65.00
H5521-1	12-24	12	.324"	15/64"	57.00
H5521-4	1/4"-20	12	.375"	17/64"	43.00
H5528-4	1/4"-28	12	.375"	17/64"	65.00
H5521-5	5/16"-18	12	.469"	21/64"	41.00
H5528-5	5/16"-24	12	.469"	21/64"	65.00
H5521-6	3/8"-16	12	.562"	25/64"	44.00
H5528-6	3/8"-24	12	.562"	25/64"	65.00
H5521-7	7/16"-14	6	.656"	29/64"	44.00
H5528-7	7/16"-20	6	.656"	26/64"	65.00

Inserts only, UNF-UNC

Set	Thread	Inserts	Length	
HR1185-2	8-32	12	.246"	20.00
HR1185-3	10-24	12	.285"	21.00
HR1191-3	10-32	12	.285"	21.00
HR1185-1	12-24	12	.324"	21.00
HR1185-4	1/4"-20	12	.375"	21.00
HR1191-4	1/4"-28	12	.375"	21.00
HR1185-5	5/16"-18	12	.469"	21.00
HR1191-5	5/16"-24	12	.469"	21.00
HR1185-6	3/8"-16	12	.562"	26.00
HR1191-6	3/8"-24	12	.562"	26.00
HR1185-7	7/16"-14	6	.656"	20.00
HR1191-7	7/16"-20	6	.656"	20.00

Heli-Coil® Kits, Special

Kit	Thread	Inserts	Length	Use drill	
H5540-4	1/4"-24	12	.500"	17/64"	125.00
Gear cover screws, tappet guide screws, oil pump, etc.					
H5540-6	3/8"-20	6	.375"	25/64"	83.00
Brake drum wheel bolts 1936-1972.					
H5540-7	7/16"-16	6	.656"	29/64"	n.a.
Headbolts 1930-1973 Flatheads, 1936-1947 Knucklehead.					
H5521-8-2	1/2"-13	6	.375"	17/32"	75.00
Early Sportster engine and transmission.					
H5528-8-2	1/2"-20	6	.375"	33/64"	77.00
Primary plug, Sportster transmission.					
H5528-10-2	5/8"-18	6	.325"	41/64"	n.a.
Timing hole plug '31-up.					
H5523-14	M14-1.25	30	3/8"		165.00
Spark plugs 1948-1974 Panhead, Shovelhead, Sportster.					
H5523-18	M18-1.50	24	.500"		n.a.
Spark plugs 1930-1973 Flatheads, 1936-1947 Knucklehead.					
H5407-2	1/8"-27 NPT				170.00

Inserts only, Special

Set	Thread	Inserts	Length	
HR389-4	1/4"-24	12	.500"	25.00
HR389-6	3/8"-20	6	.375"	16.00
HR389-7-2	7/16"-16	6	.656"	24.00
HR1185-8-2	1/2"-13	6	.375"	21.00
HR1191-8-2	1/2"-20	6	.375"	24.00
HR1191-10-2	5/8"-18	6	.325"	38.00
HR512	M14-1.25	6	3/8"	17.50
HR514-6	M18-1.50	6	.500"	24.00
HR327-2	1/8"-27 NPT	12		30.00

Taps and Dies, Special Sizes

tap160-001	7/32"-32	tap	n.a.	Tank top filler strip 750cc '37-'73, tank mounting, all models '18-'35.
M1421T	1/4"-24	tap	7.00	This thread size has many applications on the older Harley's, including gear cover screws, tappet guide screws, oil pump nuts, etc.
die160-005	1/4"-24	die	n.a.	Linkert carburetor float lever pin (1196-11 and 1197-16) and bowl drain screw (1269-39), also oversize tank top screw.
tap160-003	1/4"-32	tap	n.a.	
tap160-002	1/4"-40	tap	n.a.	Linkert carburetor low and high speed needle. (in housing and in lever 1292-27)
tap160-011	9/32"-32	tap	n.a.	Bendix carburetors.
tap160-809	5/16"-32	tap	n.a.	Grease nipples, 1924 and later.
tap160-807	3/8"-20	tap	10.00	Wheel bolts 1936-1972.
die160-007	3/8"-20	die	n.a.	
tap160-416	7/16"-16	tap	n.a.	Head bolts, all Flatheads with headbolts 1930-1973, all Knuckleheads 1936-1947.
die160-006	7/16"-16	die	n.a.	
tap160-012	7/16"-24	tap	n.a.	Oversize cylinder head studs 750cc.
tap160-010	7/16"-28	tap	n.a.	750cc models '41-'73 clutch lever.
C9407-1	11/16"-16	tap	45.00	Oversize timing hole plug
tap160-004	3/4"-18	tap	n.a.	1940-1965 petrol valve nipple in tank.
die160-008	3/4"-20	die	n.a.	Linkert carburetor bowl lock nut (1268-29)
tap160-904	13/16"-24	tap	n.a.	Handlebar end screw 750cc models '31-'39, all models '31-'35.
tap160-905	7/8"-24	tap	n.a.	Handlebar end screw (3330-36), 1936-1948.
die160-009	7/8"-24	die	n.a.	Fork stem 750cc models.



Taps, high carbon steel, UNF/UNC

M1111T	4-36	4.50	M1427T	5/16"-18	5.75
M1112T	4-40	4.50	M1429T	5/16"-24	5.75
M1118T	6-32	4.50	M1434T	3/8"-16	6.00
M1124T	8-32	4.50	M1436T	3/8"-24	6.00
M1128T	10-24	4.50	M1439T	7/16"-14	7.00
M1131T	10-32	4.50	M1440T	7/16"-20	7.00
M1132T	12-24	4.50	M1444T	1/2"-13	8.00
M1135T	14-20	4.50	M1445T	1/2"-20	8.00
M1412T	3/16"-24	4.50	M1448T	9/16"-12	11.00
M1420T	1/4"-20	4.50	M1449T	9/16"-18	11.00
M1423T	1/4"-28	4.50			

Please Check Website For Availability



Dies, high carbon steel, UNF/UNC

M6112DI	4-40	8.00	M6527DI	5/16"-18	8.00
M6118DI	6-32	8.00	M6529DI	5/16"-24	8.00
M6124DI	8-32	8.00	M6534DI	3/8"-16	8.00
M6128DI	10-24	8.00	M6536DI	3/8"-24	8.00
M6131DI	10-32	8.00	M6539DI	7/16"-14	8.00
M6132DI	12-24	8.00	M6540DI	7/16"-20	8.00
M6520DI	1/4"-20	8.00	M6544DI	1/2"-13	8.00
M6523DI	1/4"-28	8.00	M6545DI	1/2"-20	8.00



Drills

General purpose drills made of fine quality high speed steel.
Hardened and tempered with extreme accuracy to retain sharpness and long life.



Fractional Sizes

M6104D	1/16"	2.00	M6112D	3/16"	3.50	M6120D	5/16"	7.00	M6128D	7/16"	12.00
M6105D	5/64"	2.00	M6113D	13/64"	3.50	M6121D	21/64"	9.00	M6129D	29/64"	15.00
M6106D	3/32"	2.00	M6114D	7/32"	3.50	M6122D	11/32"	9.00	M6130D	15/32"	15.00
M6107D	7/64"	2.00	M6115D	15/64"	5.00	M6123D	23/64"	8.75	M6131D	31/64"	17.00
M6108D	1/8"	3.00	M6116D	1/4"	5.00	M6124D	3/8"	9.50	M6132D	1/2"	17.00
M6109D	9/64"	3.00	M6117D	17/64"	5.00	M6125D	25/64"	9.50	M9134D	17/32"	32.50
M6110D	5/32"	3.00	M6118D	9/32"	5.00	M6126D	13/32"	9.50			(1/2" shank)
M6111D	11/64"	3.00	M6119D	19/64"	7.00	M6127D	27/64"	12.00			

Letter Sizes

M4101D	A	.234"	4.00	M4108D	H	.266	5.00	M4115D	O	.316	6.75	M4122D	V	.377	9.75
M4102D	B	.238	4.00	M4109D	I	.272	5.00	M4116D	P	.323	8.00	M4123D	W	.386	9.75
M4103D	C	.242	4.00	M4110D	J	.277	5.75	M4117D	Q	.332	8.00	M4124D	X	.397	11.50
M4104D	D	.246	4.00	M4111D	K	.281	5.75	M4118D	R	.339	8.00	M4125D	Y	.404	12.50
M4105D	E	.250	4.00	M4112D	L	.290	5.75	M4119D	S	.348	9.75	M4126D	Z	.413	14.50
M4106D	F	.257	5.00	M4113D	M	.295	6.75	M4120D	T	.358	9.75				
M4107D	G	.261	5.00	M4114D	N	.302	6.75	M4121D	U	.368	9.75				

Number Sizes

M8101D	1	.228	4.00	M8121D	21	.159	2.50	M8141D	41	.096	2.00	M8161D	61	.039	2.30
M8102D	2	.221	4.00	M8122D	22	.157	2.50	M8142D	42	.093	2.00	M8162D	62	.038	2.30
M8103D	3	.213	4.00	M8123D	23	.154	2.50	M8143D	43	.089	2.00	M8163D	63	.037	2.30
M8104D	4	.209	4.00	M8124D	24	.152	2.50	M8144D	44	.086	2.00	M8164D	64	.036	2.30
M8105D	5	.205	4.00	M8125D	25	.149	2.50	M8145D	45	.082	2.00	M8165D	65	.035	2.30
M8106D	6	.204	4.00	M8126D	26	.147	2.50	M8146D	46	.081	2.00	M8166D	66	.033	2.30
M8107D	7	.201	4.00	M8127D	27	.144	2.50	M8147D	47	.078	2.00	M8167D	67	.032	2.30
M8108D	8	.199	4.00	M8128D	28	.140	2.50	M8148D	48	.076	2.00	M8168D	68	.031	2.30
M8109D	9	.196	4.00	M8129D	29	.136	2.50	M8149D	49	.073	2.00	M8169D	69	.0292	2.30
M8110D	10	.193	4.00	M8130D	30	.128	2.50	M8150D	50	.070	2.00	M8170D	70	.028	2.30
M8111D	11	.191	4.00	M8131D	31	.120	2.00	M8151D	51	.067	2.00	M8171D	71	.026	2.30
M8112D	12	.189	3.50	M8132D	32	.116	2.00	M8152D	52	.063	2.00	M8172D	72	.025	2.30
M8113D	13	.185	3.50	M8133D	33	.113	2.00	M8153D	53	.059	2.00	M8173D	73	.025	2.30
M8114D	14	.182	3.50	M8134D	34	.111	2.00	M8154D	54	.055	2.00	M8174D	74	.0225	2.30
M8115D	15	.180	3.50	M8135D	35	.110	2.00	M8155D	55	.052	2.00	M8175D	75	.021	2.70
M8116D	16	.177	3.50	M8136D	36	.106	2.00	M8156D	56	.046	2.30	M8176D	76	.020	2.70
M8117D	17	.173	3.50	M8137D	37	.104	2.00	M8157D	57	.043	2.30	M8177D	77	.018	2.70
M8118D	18	.169	2.50	M8138D	38	.101	2.00	M8158D	58	.042	2.30	M8178D	78	.016	2.70
M8119D	19	.166	2.50	M8139D	39	.099	2.00	M8159D	59	.041	2.30	M8179D	79	.0145	2.70
M8120D	20	.161	2.50	M8140D	40	.098	2.00	M8160D	60	.040	2.30	M8180D	80	.0135	2.70

Screws, Bolts, Nuts

Round Head Screws

Listed by size.



R016P	6-32 x 3/8"	park	0.63
R016Z	6-32 x 3/8"	zinc	0.30
R013Z	6-32 x 7/8"	zinc	0.30
R018P	8-32 x 1/4"	park	0.56
R018	8-32 x 1/4"	cad	0.63
R018C	8-32 x 1/4"	chrome	0.75
4940-35	8-32 x 1/4"	zinc	1.50
R019P	8-32 x 5/16"	park	0.56
R019	8-32 x 5/16"	cad	0.63
R027P	8-32 x 5/8"	park	0.63
R027	8-32 x 5/8"	cad	0.69
R026Z	8-32 x 1"	zinc	0.50
R030	10-24 x 3/8"	cad	0.69
R030P	10-24 x 3/8"	park	0.63
R030Z	10-24 x 3/8"	zinc	0.30
R030C	10-24 x 3/8"	chrome	0.75
R031P	10-24 x 1/2"	park	0.63
R031Z	10-24 x 1/2"	zinc	0.30
R031C	10-24 x 1/2"	chrome	0.60
R034	10-32 x 1/4"	cad	0.50
R034P	10-32 x 1/4"	park	0.63
R034Z	10-32 x 1/4"	zinc	0.30
R034C	10-32 x 1/4"	chrome	0.60
4941-35	10-32 x 1/4"	zinc	1.00
R041P	12-24 x 3/8"	park	0.75
R041Z	12-24 x 3/8"	zinc	0.30
R043P	12-24 x 1/2"	park	0.60
R043Z	12-24 x 1/2"	zinc	0.30
R4918-35P	12-24 x 3/4"	park	1.00
R4918-35	12-24 x 3/4"	cad	1.06
R4918-35C	12-24 x 3/4"	chrome	1.50
050	1/4-24 x 7/16"	park	2.00
R050P	1/4-24 x 7/16"	park	1.38
R050	1/4-24 x 7/16"	cad	1.44
R050C	1/4-24 x 7/16"	chrome	1.63
R050NI	1/4-24 x 7/16"	Nickle	n.a.
R051P	1/4-24 x 1/2"	park	1.44
R051	1/4-24 x 1/2"	cad	1.50
R051C	1/4-24 x 1/2"	chrome	2.63
052	1/4-24 x 5/8"	park	2.00
R052P	1/4-24 x 5/8"	park	1.50
R052	1/4-24 x 5/8"	cad	1.56
R052C	1/4-24 x 5/8"	chrome	2.19
053	1/4-24 x 3/4"	park	3.00
R053	1/4-24 x 3/4"	cad	1.63
R053P	1/4-24 x 3/4"	park	1.56
053Z	1/4-24 x 3/4"	zinc	n.a.
R053C	1/4-24 x 3/4"	chrome	1.80
R053NI	1/4-24 x 3/4"	Nickle	n.a.

Fillister Head Screws

Listed by size.



R010P	6-32 x 1/4"	zinc	0.44
R010Z	6-32 x 1/4"	zinc	0.30
R011P	6-32 x 3/8"	park	0.56
R011Z	6-32 x 3/8"	zinc	n.a.
R011C	6-32 x 3/8"	chrome	0.60
R020	8-32 x 1/4"	cad	0.63
R020P	8-32 x 1/4"	park	0.56
R020Z	8-32 x 1/4"	zinc	0.30
R020C	8-32 x 1/4"	chrome	0.60
R021P	8-32 x 3/8"	park	0.63
R021	8-32 x 3/8"	cad	0.63
R021Z	8-32 x 3/8"	zinc	0.30
R021C	8-32 x 3/8"	chrome	0.60
R021NI	8-32 x 3/8"	Nickle	0.88
4918-42	8-32 x 3/8"	green	0.40
R024P	8-32 x 3/4"	park	0.63
R024Z	8-32 x 3/4"	zinc	n.a.
R024C	8-32 x 3/4"	chrome	n.a.
R026P	8-32 x 1"	park	0.75
R030AP	10-24 x 3/8"	park	0.75
R030A	10-24 x 3/8"	cad	0.75
R030AZ	10-24 x 3/8"	zinc	0.30
R032P	10-24 x 1/2"	park	0.63
R032	10-24 x 1/2"	cad	0.69
R032C	10-24 x 1/2"	chrome	0.81
R033P	10-24 x 5/8"	park	0.63
R033	10-24 x 5/8"	cad	0.69
R033Z	10-24 x 5/8"	zinc	0.30
R033C	10-24 x 5/8"	chrome	0.85
R033LP	10-24 x 3/4"	park	0.75
R033L	10-24 x 3/4"	cad	0.75
R033LC	10-24 x 3/4"	chrome	0.90
R033XL	10-24 x 1"	cad	0.75
R033XLC	10-24 x 1"	chrome	0.90
R035P	10-32 x 3/8"	park	0.63
R035	10-32 x 3/8"	cad	0.69
R035C	10-32 x 3/8"	chrome	0.81
R035NI	10-32 x 3/8"	Nickle	0.65
R036P	10-32 x 1/2"	park	0.63
R036	10-32 x 1/2"	cad	0.69
R036C	10-32 x 1/2"	chrome	0.81
R036NI	10-32 x 1/2"	Nickle	n.a.
R037P	10-32 x 5/8"	park	0.63
R037	10-32 x 5/8"	cad	0.69
R037C	10-32 x 5/8"	chrome	1.13
R037NI	10-32 x 5/8"	Nickle	0.90
R038P	10-32 x 3/4"	park	0.63
R038Z	10-32 x 3/4"	zinc	0.50
R038C	10-32 x 3/4"	chrome	n.a.
R038AP	10-32 x 7/8"	park	0.63
R038A	10-32 x 7/8"	cad	0.50
R1523-26	10-32 x 1-1/4"	zinc	1.50
R042P	12-24 x 1/2"	park	0.63
R042	12-24 x 1/2"	cad	0.69
R042C	12-24 x 1/2"	chrome	0.88
R042NI	12-24 x 1/2"	Nickle	n.a.
4967-42MD	12-24 x 1/2"	special	1.50
R044Z	12-24 x 7/8"	zinc	0.50
R044C	12-24 x 7/8"	chrome	n.a.

Oval Countersunk Head Screws

Listed by size.



2265W	12-24 x 3/8"	zinc	1.00
R048C	12-24 x 3/8"	chrome	0.80
R048AP	12-24 x 1/2"	park	0.94
R048A	12-24 x 1/2"	cad	1.00
R048AC	12-24 x 1/2"	chrome	1.25
R045	12-24 x 21/32"	cad	1.38
047	12-24 x 13/16"	park	2.00
R047P	12-24 x 13/16"	park	1.38
047cad	12-24 x 13/16"	cad	2.00
R047	12-24 x 13/16"	cad	1.44
R047C	12-24 x 13/16"	chrome	1.69
R1409-41MP	12-24 x 2-1/4"	park	4.06
R1409-41M	12-24 x 2-1/4"	cad	4.06
R057P	1/4-24 x 13/16"	park	1.56
R057	1/4-24 x 13/16"	cad	1.56
R057C	1/4-24 x 13/16"	chrome	2.19
R057NI	1/4-24 x 13/16"	Nickle	1.75
R2268-36P	1/4-24 x 13/16"	park	1.25
R2268-36	1/4-24 x 13/16"	cad	1.44
R2268-36C	1/4-24 x 13/16"	chrome	1.88
056	1/4-24 x 1-1/8"	park	1.95
R056P	1/4-24 x 1-1/8"	park	1.88
R056	1/4-24 x 1-1/8"	cad	1.88
R056C	1/4-24 x 1-1/8"	chrome	2.31
R056NI	1/4-24 x 1-1/8"	Nickle	n.a.
2341HW	1/4-24 x 1-1/8"	zinc	2.00
R1523-32P	1/4-24 x 2"	park	3.75
R1523-32	1/4-24 x 2"	cad	3.75
R1523-32C	1/4-24 x 2"	chrome	5.00
R1523-36P	1/4-24 x 3"	park	4.06
R1523-36	1/4-24 x 3"	cad	4.06
R1523-36C	1/4-24 x 3"	chrome	5.63
058	5/16-18 x 13/16"	bare	3.00
R3805-30AP	5/16-24 x 19/32"	park	5.00
R3805-30A	5/16-24 x 19/32"	cad	5.00
R3749-30P	5/16-24 x 27/32"	park	6.00
R3749-30	5/16-24 x 27/32"	cad	6.00
R3749-30C	5/16-24 x 27/32"	chrome	7.00



Hex Head Bolts



Listed by size:

R4518-36	10-32 x 5/16"		cad	2.25
R4518-36C	10-32 x 5/16"		chrome	3.00
R1409-36P	12-24 x 3/8"		park	2.50
R1409-36	12-24 x 3/8"		cad	2.50
R054Z	1/4-20 x 1"	'grade'	zinc	0.40
R054C	1/4-20 x 1"		chrome	1.30
R692-41P	1/4-20 x 1-1/4"		park	1.88
R692-41	1/4-20 x 1-1/4"	'grade'	cad	1.88
R692-41C	1/4-20 x 1-1/4"		chrome	2.50
054A	1/4-24 x 1/2"		zinc	4.00
1123-29	1/4-24 x 5/8"		park	1.50
R1123-29	1/4-24 x 5/8"		cad	3.13
R1123-29C	1/4-24 x 5/8"		chrome	4.06
053E	1/4-24 x 3/4"		park	3.00
R053EP	1/4-24 x 3/4"		park	2.50
7223-34	1/4-24 x 3/4"	'1035 cp'	park	n.a.
R7223-34	1/4-24 x 3/4"		cad	2.50
R7223-34C	1/4-24 x 3/4"		chrome	3.75
R13332-25AP	1/4-24 x 1-5/8"		park	3.13
13332-25Acad	1/4-24 x 1-5/8"	'rockford'	cad	3.20
R13332-25A	1/4-24 x 1-5/8"		cad	3.13
R13332-25AC	1/4-24 x 1-5/8"		chrome	4.06
R1725-30P	1/4-28 x 7/16"		park	1.88
R054WZ	1/4-28 x 5/8"		zinc	0.50
R054WC	1/4-28 x 5/8"		chrome	1.30
R4017P	5/16-18 x 1"	'1038 cp'	park	3.50
443-37P	5/16-18 x 2-3/4"		park	n.a.
443-37	5/16-18 x 2-3/4"	'1035 cp'	cad	3.00
061	5/16-24 x 1/2"	'1035 cp'	park	2.50
R061P	5/16-24 x 1/2"	'1038 cp'	park	1.63
R061Z	5/16-24 x 1/2"	'grade'	zinc	0.35
R061	5/16-24 x 1/2"	'1038 cp'	cad	1.69
R061C	5/16-24 x 1/2"		chrome	1.40
060	5/16-24 x 9/16"		park	3.00
R064PS	5/16-24 x 3/4"		park	1.81
R064P	5/16-24 x 3/4"	'1038 cp'	park	1.81
R064Z	5/16-24 x 3/4"	'grade'	zinc	0.60
R064	5/16-24 x 3/4"	'1038 cp'	cad	1.88
R064C	5/16-24 x 3/4"		chrome	2.13
R064EP	5/16-24 x 7/8"	'1038 cp'	park	2.19
R066PS	5/16-24 x 1"	'1038 cp'	park	2.19
R066P	5/16-24 x 1"	'1038 cp'	park	2.19
R066Z	5/16-24 x 1"	'grade'	zinc	0.75
R066C	5/16-24 x 1"		chrome	1.30
R066AP	5/16-24 x 1-1/8"	'1038 cp'	park	2.31
R066A	5/16-24 x 1-1/8"	'1038 cp'	cad	2.31
R3748-26P	5/16-24 x 1-1/8"	'1038 cp'	park	2.50
R3748-26	5/16-24 x 1-1/8"	'grade'	cad	2.50
R3748-26C	5/16-24 x 1-1/8"		chrome	2.50
R066BP	5/16-24 x 1-3/8"	'1038 cp'	park	2.50
069	5/16-24 x 1-3/8"	dome head	park	1.50
R068PS	5/16-24 x 1-13/16"		park	2.63
R068P	5/16-24 x 1-13/16"	'1038 cp'	park	2.63
R068	5/16-24 x 1-13/16"	'1038 cp'	cad	2.81
R068C	5/16-24 x 1-13/16"		chrome	1.50
R3529-37PS	5/16-24 x 2-1/4"		park	3.13
R3529-37P	5/16-24 x 2-1/4"	'1038 cp'	park	3.13
R3529-37	5/16-24 x 2-1/4"	'1038 cp'	cad	3.25
R3529-37C	5/16-24 x 2-1/4"		chrome	3.75

About hex head markings:

'41 and earlier bolts were usually made by Harley and were not marked (plain head). War-time production saw the arrival of other suppliers, these could be marked "1035 cp" or "1038 cp".



'1035 cp'



'1038 cp'



'grade'

Hex Head Bolts (continued)

R3529-36PS	5/16-24 x 2-5/8"		park	3.44
R3529-36P	5/16-24 x 2-5/8"	'1038 cp'	park	3.44
R3529-36C	5/16-24 x 2-5/8"		chrome	3.75
R070P	3/8-16 x 3/4"	'1035 cp'	park	3.38
R070Z	3/8-16 x 3/4"	'grade'	zinc	0.50
R070	3/8-16 x 3/4"	'1035 cp'	cad	3.44
R070C	3/8-16 x 3/4"		chrome	1.40
R072Z	3/8-16 x 7/8"	'grade'	zinc	0.50
R2263-36BP	3/8-16 x 1"		park	2.19
R2263-36B	3/8-16 x 1"	'grade'	cad	1.85
R2263-36BC	3/8-16 x 1"		chrome	2.25
071	3/8-16 x 1-3/16"		park	4.00
R071P	3/8-16 x 1-3/16"		park	3.75
R071	3/8-16 x 1-3/16"		cad	3.75
R071C	3/8-16 x 1-3/16"		chrome	4.69
073	3/8-16 x 1-3/8"		park	5.00
R073P	3/8-16 x 1-3/8"		park	3.75
R073	3/8-16 x 1-3/8"		cad	3.75
R073C	3/8-16 x 1-3/8"		chrome	4.69
R444-30P	3/8-16 x 3-1/4"		park	4.38
R444-30	3/8-16 x 3-1/4"		cad	4.38
R444-30C	3/8-16 x 3-1/4"		chrome	5.31
R074P	3/8-24 x 3/4"		park	2.50
R074Z	3/8-24 x 3/4"	'grade'	zinc	0.50
R074C	3/8-24 x 3/4"		chrome	1.40
R074NI	3/8-24 x 3/4"		Nickle	n.a.
2823-26	3/8-24 x 7/8"		park	7.00
R2823-26P	3/8-24 x 7/8"		park	5.00
R2823-26	3/8-24 x 7/8"		cad	5.00
R2823-26C	3/8-24 x 7/8"		chrome	6.75
4336W	3/8-24 x 1-1/8"	'grade'	zinc	2.50
2100-16	3/8-24 x 1-1/8"	dome head	park	8.00
R2100-16C	3/8-24 x 1-1/8"	dome head	chrome	9.38
R079P	3/8-24 x 1-1/8"		park	4.06
R079	3/8-24 x 1-1/8"		cad	4.19
R079C	3/8-24 x 1-1/8"		chrome	4.81
R078C	3/8-24 x 1-1/4"		chrome	1.50
R075	3/8-24 x 1-3/8"		cad	5.63
R075C	3/8-24 x 1-3/8"		chrome	6.25
R075P	3/8-24 x 1-3/8"		park	5.63
R437-26P	3/8-24 x 1-3/4"	'1035 cp'	park	6.25
R437-26	3/8-24 x 1-3/4"	'1035 cp'	cad	6.25
R437-26C	3/8-24 x 1-3/4"		chrome	7.50
R437-36P	3/8-24 x 2-5/8"		park	6.25
R437-36	3/8-24 x 2-5/8"	'1038 cp'	cad	6.25
R437-36C	3/8-24 x 2-5/8"		chrome	7.50
R438-36P	3/8-24 x 3-5/16"	'1038 cp'	park	7.50
R438-36	3/8-24 x 3-5/16"	'1038 cp'	cad	7.50
R438-36C	3/8-24 x 3-5/16"		chrome	8.75
2807-30	7/16-20 x 1"		park	5.00
2807-3035	7/16-20 x 1"	'1035 cp'	park	8.00
R080P	7/16-20 x 1-1/2"		park	6.25
R080Z	7/16-20 x 1-1/2"	'grade'	zinc	0.70
R080C	7/16-20 x 1-1/2"		chrome	1.70
R6033-30P	7/16-20 x 1-5/16"	'1035 cp'	park	5.13
R6033-30	7/16-20 x 1-5/16"	'1035 cp'	cad	5.13
R6033-30C	7/16-20 x 1-5/16"		chrome	6.88
14-30	7/16-20 x 1-3/4"		park	10.00

Screws, Bolts, Nuts

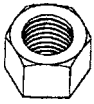

About nuts:

Early 1940's and earlier nuts were mostly manufactured by H-D and were machined from stock. These nuts are clearly different than the later style nuts. We have marked all the nuts on this page with a 'm' to indicate that they are machined.

'machined'
(sharp edges)



not 'machined'
(round edges)

Nuts

Listed by size:

R0101P	6-32 x 7/64" x 5/16"	park	0.50
R0101B	6-32 x 7/64" x 5/16"	brass	0.50
R0101Z	6-32 x 7/64" x 5/16"	zinc	0.40
R0103P	8-32 x 1/8" x 11/32"	park	0.50
R0103	8-32 x 1/8" x 11/32"	cad	0.50
R0103Z	8-32 x 1/8" x 11/32"	zinc	0.40
R0104P	10-24 x 1/8" x 3/8"	park	0.50
R0104	10-24 x 1/8" x 3/8"	cad	0.50
R0104Z	10-24 x 1/8" x 3/8"	zinc	0.40
R0104C	10-24 x 1/8" x 3/8"	chrome	0.75
R0104FP	10-24 x 3/8" flexlock	park	1.06
R0104F	10-24 x 3/8" flexlock	cad	1.06
R0104FNI	10-24 x 3/8" flexlock	Nickle	1.35
4434-23	10-24 x 1/4" x 3/8"	'm' cad	1.70
0105cop	10-32 x 1/8" x 5/16"	brass	0.70
0105copm	10-32 x 1/8" x 5/16"	'm' brass	1.30
0105cad	10-32 x 1/8" x 5/16"	cad	1.00
R0105Z	10-32 x 1/8" x 5/16"	zinc	0.30
R0105C	10-32 x 1/8" x 5/16"	chrome	0.50
R0105AP	10-32 x 1/8" x 3/8"	park	0.50
R0105AZ	10-32 x 1/8" x 3/8"	zinc	0.50
R0105AC	10-32 x 1/8" x 3/8"	chrome	n.a.
R0106P	12-24 x 5/32" x 7/16"	park	0.50
R0106	12-24 x 5/32" x 7/16"	cad	0.50
R0106Z	12-24 x 5/32" x 7/16"	zinc	0.30
R0107C	1/4-20 x 1/4" x 7/16"	chrome	1.13
R0107P	1/4-20 x 1/4" x 1/2"	'm' park	1.13
R0107	1/4-20 x 1/4" x 1/2"	'm' cad	1.19
0108	1/4-24 x 5/32" x 7/16"	'm' park	1.50
R0108P	1/4-24 x 5/32" x 7/16"	'm' park	1.13
R0108M	1/4-24 x 5/32" x 7/16"	'm' cad	1.19
R0108C	1/4-24 x 5/32" x 7/16"	chrome	0.88
R0108NI	1/4-24 x 5/32" x 7/16"	'm' Nickle	1.56
0109	1/4-24 x 7/32" x 7/16"	'm' park	2.00
0109C	1/4-24 x 7/32" x 7/16"	'm' chrome	2.30
451-37	1/4-24 x 1/4" x 1/2"	park	2.00
R451-37P	1/4-24 x 1/4" x 1/2"	'm' park	1.13
R451-37	1/4-24 x 1/4" x 1/2"	'm' cad	1.13
R451-37C	1/4-24 x 1/4" x 1/2"	'm' chrome	1.56
R0111P	5/16-18 x 17/64" x 1/2"	'm' park	1.13
R0111Z	5/16-18 x 17/64" x 1/2"	zinc	0.30
R0111	5/16-18 x 17/64" x 1/2"	'm' cad	1.19
R0111C	5/16-18 x 17/64" x 1/2"	chrome	1.00
R0111NI	5/16-18 x 17/64" x 1/2"	Nickle	1.00
R0112P	5/16-24 x 17/64" x 7/16"	'm' park	1.25
R0112	5/16-24 x 17/64" x 7/16"	'm' cad	1.38
R0112NI	5/16-24 x 17/64" x 7/16"	'm' Nickle	1.50
R0117BP	5/16-24 x 3/16" x 1/2"	park	1.25
R0117B	5/16-24 x 3/16" x 1/2"	cad	1.38
R0117BC	5/16-24 x 3/16" x 1/2"	chrome	1.50
R0117P	5/16-24 x 17/64" x 1/2"	'm' park	1.19
R0117Z	5/16-24 x 17/64" x 1/2"	zinc	0.30
R0117M	5/16-24 x 17/64" x 1/2"	'm' cad	1.25
R0117C	5/16-24 x 17/64" x 1/2"	chrome	0.94
R0117NI	5/16-24 x 17/64" x 1/2"	Nickle	1.35
R7725	5/16-24 x 1/2" flexloc	cad	1.88
R7725C	5/16-24 x 1/2" flexloc	chrome	1.94
R0117A	5/16-24 x 5/16" x 9/16"	'm' park	1.44
R0120P	3/8-16 x 5/16" x 9/16"	'm' park	1.44
R0120	3/8-16 x 5/16" x 9/16"	'm' cad	1.50
R0120C	3/8-16 x 5/16" x 9/16"	'm' chrome	1.69
R0120NI	3/8-16 x 5/16" x 9/16"	'm' Nickle	1.75
R0129AP	3/8-24 x 7/32" x 9/16"	park	1.25
R0129A	3/8-24 x 7/32" x 9/16"	cad	1.25
R0129AC	3/8-24 x 7/32" x 9/16"	chrome	1.69
R0129C	3/8-24 x 7/32" x 9/16"	chrome	1.75

Nuts (continued)

0129	3/8-24 x 1/4" x 9/16"	'm' park	1.50
0129.50pack	Bag of 50 nuts	'm' park	45.00
R0129P	3/8-24 x 1/4" x 9/16"	'm' park	1.44
R0129	3/8-24 x 1/4" x 9/16"	'm' cad	1.56
0129C	3/8-24 x 1/4" x 9/16"	'm' chrome	2.50
0129Z	3/8-24 x 1/4" x 9/16"	'm' zinc	2.00
R0127P	3/8-24 x 21/64" x 9/16"	'm' park	1.50
R0127Z	3/8-24 x 21/64" x 9/16"	zinc	0.50
R0127	3/8-24 x 21/64" x 9/16"	'm' cad	1.63
R0127C	3/8-24 x 21/64" x 9/16"	chrome	1.06
R0127NI	3/8-24 x 21/64" x 9/16"	'm' Nickle	1.60
R0123P	3/8-24 x 1/2" x 9/16"	'm' park	1.50
R0123	3/8-24 x 1/2" x 9/16"	'm' cad	1.69
R0123C	3/8-24 x 1/2" x 9/16"	chrome	2.81
R0123NI	3/8-24 x 1/2" x 9/16"	'm' Nickle	1.90
2633-30A	3/8-24 x 7/32" x 5/8"	'm' bare	2.00
R0125P	3/8-24 x 1/4" x 5/8"	'm' park	1.50
R2318-36AP	3/8-24 x 21/64" x 5/8"	'm' park	1.63
R2318-36A	3/8-24 x 21/64" x 5/8"	'm' cad	1.69
R2318-36AC	3/8-24 x 21/64" x 5/8"	'm' chrome	1.88
R0128P	3/8-24 x 9/16" castle	park	2.00
R0128	3/8-24 x 9/16" castle	cad	2.13
R0128C	3/8-24 x 9/16" castle	chrome	2.31
R0128NI	3/8-24 x 9/16" castle	Nickle	2.00
3910-37	3/8-24 x 15/16" castle	park	3.00
R3910-37P	3/8-24 x 15/16" castle	park	3.44
R3910-37	3/8-24 x 15/16" castle	cad	3.44
R3910-37C	3/8-24 x 15/16" castle	chrome	4.38
R7775P	3/8-24 x 9/16" flexloc	park	2.81
R7775	3/8-24 x 9/16" flexloc	cad	2.81
R0130P	7/16-18 x 1/4" x 11/16"	'm' park	1.63
R0130	7/16-18 x 1/4" x 11/16"	'm' cad	2.06
R0130NI	7/16-18 x 1/4" x 11/16"	'm' Nickle	1.80
R4166-28P	7/16-20 x 1/4" x 9/16"	'm' park	1.75
R4166-28	7/16-20 x 1/4" x 9/16"	'm' cad	1.88
R4166-28C	7/16-20 x 1/4" x 9/16"	'm' chrome	2.50
R0136P	7/16-20 x 1/4" x 5/8"	'm' park	1.63
R0136	7/16-20 x 1/4" x 5/8"	'm' cad	1.69
R0136C	7/16-20 x 1/4" x 5/8"	'm' chrome	1.75
R0133P	7/16-20 x 3/8" x 5/8"	'm' park	1.63
R0133	7/16-20 x 3/8" x 5/8"	'm' cad	1.69
R0133C	7/16-20 x 3/8" x 5/8"	'm' chrome	1.88
0134	7/16-20 x 1/2" x 5/8"	'm' park	2.00
R0134P	7/16-20 x 1/2" x 5/8"	'm' park	1.69
R0134	7/16-20 x 1/2" x 5/8"	'm' cad	1.81
R0134C	7/16-20 x 1/2" x 5/8"	'm' chrome	3.13
R0134NI	7/16-20 x 1/2" x 5/8"	'm' Nickle	2.50
0138	7/16-20 x 5/8" castle	cad	3.20
R7825P	7/16-20 x 5/8" flexlock	park	3.75
R7825	7/16-20 x 5/8" flexlock	cad	3.94
R7872	7/16-20 x 5/8" red cap		
R7872B	7/16-20 x 5/8" black cap		2.00
R7863	7/16-20 x 3/8" x 3/4"	'm' cad	
R7863C	7/16-20 x 3/8" x 3/4"	'm' chrome	2.25
R2644-30P	7/16-20 x 7/16" x 3/4"	'm' park	2.50
R2644-30	7/16-20 x 7/16" x 3/4"	'm' cad	2.50
R2644-30C	7/16-20 x 7/16" x 3/4"	'm' chrome	3.44
2641-30	7/16-20 x 9/32" x 13/16"	'm' park	2.00
2641-30C	7/16-20 x 9/32" x 13/16"	'm' chrome	3.00
R4079-26P	7/16-20 x 13/32" x 13/16"	'm' park	5.94
R4079-26	7/16-20 x 13/32" x 13/16"	'm' cad	5.94
0131	7/16-24 x 1/4" x 3/4"	'm' park	2.00
0135A	1/2-13 x 1/2" x 7/8"	zinc	
R2634-30AP	1/2-20 x 3/8" x 3/4"	'm' park	2.50
R2634-30A	1/2-20 x 3/8" x 3/4"	'm' cad	2.50
R2634-30AC	1/2-20 x 3/8" x 3/4"	'm' chrome	3.44

Nuts (continued)

R2634-36	1/2-20 x 3/4 acorn nut	park	5.00
R2634-36C	1/2-20 x 3/4 acorn nut	chrome	5.63
R2643-31	1/2-20 x 5/16" x 13/16" 'm'	park	2.13
R2643-31cad	1/2-20 x 5/16" x 13/16" 'm'	cad	2.19
R6032-36P	1/2-20 x 7/16" x 7/8" 'm'	park	2.25
7914	1/2-20 x 7/16" x 7/8"	zinc	4.00
7907	1/2-20 x 7/16" x 7/8" 'm'	bare	3.00
R4178-42P	1/2-20 x 7/8" castle nut	park	6.25
R4178-42	1/2-20 x 7/8" castle nut	cad	7.50
R4178-42C	1/2-20 x 7/8" castle nut	chrome	9.38
R7926	1/2-20 x 9/32" x 1-3/16" 'm'		
R6036-36BP	9/16-18 x 11/32" x 15/16" 'm'	park	3.13
R6036-36B	9/16-18 x 11/32" x 15/16" 'm'	cad	3.31
R3996-36P	5/8-18 x 7/16" x 7/8" 'm'	park	3.13
R3996-36	5/8-18 x 7/16" x 7/8" 'm'	cad	3.38
R3996-36C	5/8-18 x 7/16" x 7/8" 'm'	chrome	5.00
R7974P	5/8-18 x 7/32" x 15/16" 'm'	park	
R7974	5/8-18 x 7/32" x 15/16" 'm'	cad	3.13
364-29	5/8-18 x 7/32" x 15/16" 'm'		8.00
R364-29	5/8-18 x 7/32" x 15/16" 'm'		6.50
R2274-36	5/8-18 x 7/32" x 1" 'm'		3.25

Nuts (continued)

2050-12	5/8-18 x 5/16" x 1-1/16" 'm'	park	7.00
0142	5/8 -24 x 7/32" x 7/8" 'm'	park	3.00
R2050-30	11/16-18 x 1" special	'm' park	13.75
364-37	11/16-18 x 7/32" x 1-1/16" 'm'		4.00
R8011	11/16-18 x 7/32" x 1-3/16" 'm'		5.50
3929-44	11/16-24 x 15/16" special	'm' park	6.00
R3929-44P	11/16-24 x 15/16" special	'm' park	8.75
R3929-44	11/16-24 x 15/16" special	'm' cad	8.75
R3929-44C	11/16-24 x 15/16" special	'm' chrome	11.25
R8025	3/4-16 x 11/16" x 1-1/16" 'm'		8.75
2932-14	3/4-18 x 7/16" x 1-1/16" 'm'	park	6.00
R364-36	3/4-18 x 9/32" x 1-3/16" 'm'		8.50
R365-15	13/16-18 x 1/4" x 1-3/16" 'm'		11.56
R4005-35P	13/16-24 x 19/64" x 1-3/16" 'm'	park	13.75
R4005-35	13/16-24 x 19/64" x 1-3/16" 'm'	cad	13.75
R4005-35C	13/16-24 x 19/64" x 1-3/16" 'm'	chrome	15.94
R4184-30P	13/16-24 x 3/8" x 1-3/16" 'm'	park	7.50
R4184-30	13/16-24 x 3/8" x 1-3/16" 'm'	cad	8.13
R4184-30C	13/16-24 x 3/8" x 1-3/16" 'm'	chrome	10.00

Washers

Listed by size:

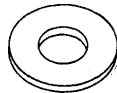

R6189W	5/32" x 25/64" x .032"	brass	0.35
R0202A	3/16" x 21/64" x 1/64"	zinc	0.40
R0201P	3/16" x 7/16" x 1/32"	park	0.31
R0201	3/16" x 7/16" x 1/32"	zinc	0.38
R0201A	13/64" x 3/8" x 1/32"	brass	0.50
R0205P	7/32" x 1/2" x 1/16"	park	0.38
0207	1/4" x 7/16" x 1/32"	park	1.00
R6099	1/4" x 7/16" x 1/16"	zinc	0.40
R6099C	1/4" x 7/16" x 1/16"	chrome	0.44
1417-42	1/4" x 1/2" x 1/16"		0.80
R0208AP	1/4" x 9/16" x 1/16"	park	0.38
R0207B	1/4" x 9/16" x 1/32"	zinc	0.30
R0208P	1/4" x 5/8" x 1/16"	park	0.38
R0208Z	1/4" x 5/8" x 1/16"	zinc	0.30
R0208C	1/4" x 5/8" x 1/16"	chrome	0.50
R0208NI	1/4" x 5/8" x 1/16"	Nickle	0.50
R0211P	9/32" x 15/32" x 1/32"	park	0.63
R0213P	5/16" x 1/2" x 3/32"	park	0.50
R0213NI	5/16" x 1/2" x 3/32"	Nickle	0.63
R0212P	5/16" x 9/16" x 1/32"	park	0.50
R0212	5/16" x 9/16" x 1/32"	stainless	0.30
R0212C	5/16" x 9/16" x 1/32"	chrome	
R6316WP	5/16" x 5/8" x 1/16"	park	0.31
R6316W	5/16" x 5/8" x 1/16"	cad/zinc	0.38
R6316WC	5/16" x 5/8" x 1/16"	chrome	0.50
R0214P	5/16" x 11/16" x 1/16"	park	0.50
R0214	5/16" x 11/16" x 1/16"	cad	0.50
R0214C	5/16" x 11/16" x 1/16"	chrome	0.65
6327B	5/16" x 3/4" x 1/16"	park	2.00
R6327B	5/16" x 3/4" x 1/16"	zinc	0.30
R0215P	5/16" x 15/16" x 1/16"	park	0.63
R0212AP	21/64" x 15/16" x 3/16"	park	1.13
R2788-30	3/8" x 9/16" x 1/16"	park	1.00
R6377	3/8" x 5/8" x 1/32"	brass	0.50
R0226P	3/8" x 5/8" x 3/64"	park	0.63
R0224AP	3/8" x 23/32" x 1/16"	park	0.63

Washers (continued)

R0224P	3/8" x 13/16" x 1/16"	park	0.63
R0224	3/8" x 13/16" x 1/16"	cad	0.63
R0224C	3/8" x 13/16" x 1/16"	chrome	0.88
R0224NI	3/8" x 13/16" x 1/16"	Nickle	0.70
R0225P	3/8" x 13/16" x 7/64"	park	0.63
R0223AP	3/8" x 7/8" x 1/8"	park	1.13
R0223A	3/8" x 7/8" x 1/8"	cad	1.13
R0223AC	3/8" x 7/8" x 1/8"	chrome	1.38
R0223P	3/8" x 1" x 1/8"	park	1.13
R0223	3/8" x 1" x 1/8"	cad	1.13
R0223C	3/8" x 1" x 1/8"	chrome	1.50
R13457-40P	3/8" x 1-1/8" x 1/8"	park	1.25
R13457-40cad	3/8" x 1-1/8" x 1/8"	cad	1.38
R13457-40C	3/8" x 1-1/8" x 1/8"	chrome	3.13
R0227AP	25/64" x 13/16" x 1/8"	park	0.75
3572-36C	13/32" x 5/8" x 13/32"	park	0.60
R3572-36C	13/32" x 5/8" x 13/32"	brass	0.50
2952-35	13/32" x 11/16" x 1/4"	park	2.50
0228	7/16" x 21/32" x 1/16"	park	1.50
R2242-36B	7/16" x 3/4" x 1/64"	zinc	0.50
R15-36P	7/16" x 3/4" x 1/8"	park	0.75
R15-36	7/16" x 3/4" x 1/8"	cad	0.75
R15-36C	7/16" x 3/4" x 1/8"	chrome	1.06
R0232P	7/16" x 13/16" x 3/32"	park	0.88
0232	7/16" x 13/16" x 3/32"	cad	1.50
R0232C	7/16" x 13/16" x 3/32"	chrome	1.25
0230	7/16" x 15/16" x 1/8"	park	2.00
R0230P	7/16" x 15/16" x 1/8"	park	1.06
R0230	7/16" x 15/16" x 1/8"	cad	1.06
R0230C	7/16" x 15/16" x 1/8"	chrome	1.25
R0234	29/64" x 1-1/8" x .015"		0.75
R0231P	29/64" x 1-1/8" x 3/32"	park	1.25
0231W	29/64" x 1-1/8" x 3/32"	cad	
R1643-29	15/32" x 3/4" x .033"		0.80
R1643-29S	15/32" x 3/4" x .070"		0.80
1643-30	15/32" x 3/4" x .072"	park	2.00
R13458-36P	1/2" x 1-1/8" x 3/32"	park	1.25
R13458-36cad	1/2" x 1-1/8" x 3/32"	cad	1.38
R13458-36C	1/2" x 1-1/8" x 3/32"	chrome	1.75
R6581	17/32" x 15/16" x .025"	brass	0.95

Screws, Bolts, Nuts

Lockwashers

Listed by size:

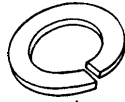

R0250	No.4 x 17/64" x 1/32"	zinc	0.20
R0251	No.6 x 15/64" x 1/32"	zinc	0.20
R0252P	No.8 x 5/32" x 1/32"	park	0.25
R0252	No.8 x 5/32" x 1/32"	zinc	0.20
R0252C	No.8 x 5/32" x 1/32"	chrome	0.38
R0254P	No.10 x 21/64" x 3/64"	park	0.25
R0254	No.10 x 21/64" x 3/64"	zinc	0.20
R0254C	No.10 x 21/64" x 3/64"	chrome	0.38
0253	3/16" x 3/8" x 3/64"	park	0.25
R0255P	No.12 x 11/32" x 3/64"	park	0.25
R0255	No.12 x 11/32" x 3/64"	zinc	0.20
0255A	7/32" x 15/32" x 3/64"	park	1.30
R0256P	1/4" x 1/2" x 1/16"	park	0.25
R0256	1/4" x 1/2" x 1/16"	zinc	0.25
R0256C	1/4" x 1/2" x 1/16"	chrome	0.38
R0259P	5/16" x 9/16" x 1/16"	park	0.25
R0259	5/16" x 9/16" x 1/16"	zinc	0.25
R0259C	5/16" x 9/16" x 1/16"	chrome	0.38
R0261B	3/8" x 5/8" x 3/32"	black	0.20
R0261P	3/8" x 5/8" x 3/32"	park	0.25
R0261	3/8" x 5/8" x 1/16"	zinc	0.25
R0261C	3/8" x 5/8" x 3/32"	chrome	0.38
R0262P	3/8" x 13/16" x 1/16"	park	4.38
R0265P	7/16" x 11/16" x 3/32"	park	0.69
R0265	7/16" x 11/16" x 3/32"	zinc	0.75
R0265C	7/16" x 11/16" x 3/32"	chrome	0.94
R0265AP	7/16" x 3/4" x 3/32"	park	1.06
R0265A	7/16" x 3/4" x 3/32"	zinc	0.30
R0265AC	7/16" x 3/4" x 3/32"	chrome	0.69
R0266P	7/16" x 3/4" x 1/8"	park	0.75
R0266	7/16" x 3/4" x 1/8"	cad	0.75
R0266C	7/16" x 3/4" x 1/8"	chrome	0.85
0266	7/16" x 13/16" x 3/32"	park	1.50
R0269P	9/16" x 15/16" x 3/32"	park	1.50
R0269	9/16" x 15/16" x 3/32"	zinc	0.30
R7043	3/4" x 1-1/4" x 3/16"	zinc	0.50

0253, 0255A, 0262, 0266 are special lockwashers (larger o.d.)

Special Lockwashers

Listed by size:

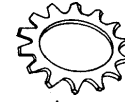
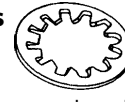

R7206W	No.4	external tooth	zinc	0.20
R0351	No.6	internal tooth	zinc	0.20
R7143	No.8	external tooth	zinc	0.30
R0352	No.8	internal tooth	zinc	0.20
R0353	No.8	external-internal	zinc	0.25
R0354	No.10	external tooth	zinc	0.20
R0356	No.10	internal tooth	zinc	0.20
R7121	No.12	internal tooth	zinc	0.20
R0359	1/4"	internal tooth	zinc	0.20
R0363P	1/4"	external tooth	park	0.38
R0363	1/4"	external tooth	zinc	0.20
R7229W	1/4"	external-internal	zinc	0.35
R0365P	1/4"	countersunk	park	0.38
R0365	1/4"	countersunk	zinc	0.25
R0360	5/16"	internal tooth	zinc	0.20
R7232	5/16"	external tooth	zinc	0.20
R0370P	5/16"	countersunk	park	0.50
R0370	5/16"	countersunk	zinc	0.30
R7042	5/16"	high collar	zinc	0.30
R0374	3/8"	internal tooth	zinc	0.20
R7145W	3/8"	external tooth	zinc	0.25
R6027W	3/8"	countersunk	zinc	0.35
R7045	3/8"	high collar	zinc	0.30
R0362	7/16"	internal tooth	zinc	0.20
R7129	1/2"	internal tooth	zinc	0.25
R0390	1/2"	external tooth	zinc	0.25
R7242	5/8"	external tooth	zinc	0.30
R7142	3/4"	internal tooth	zinc	0.30
R7144	3/4"	external tooth	zinc	0.30

Steel Balls



R1297-26	5/32" steel ball	0.35
R0279	3/16" steel ball	
R2472-41B	7/32" steel ball	0.20
R0280	1/4" steel ball	0.20
R0282	5/16" steel ball	0.30
R704-36	3/8" steel ball	0.40
R2251-36	1/2" steel ball	1.00

Grease Fittings



R0340	Alemite fitting	'24-'37	Nickle	3.75
R0344	Grease nipple	straight	zinc	2.63
R0344C	Grease nipple	straight	chrome	2.75
R0344P	Grease nipple	straight	park	2.63
0345	Grease nipple	67.5° angle	cad	3.00
R0347	Grease nipple	90° angle	zinc	2.00

Rivets



1647-31A	1/8" x 9/32"	brass	tubular	0.50
4046-31	9/64" x 9/32"	brass	tubular	0.30
R4033-35	5/32" x 1/2"	steel	round head	0.25
2485-41A	3/16" x 7/32"	brass	countersunk	0.20
R2485-41	3/16" x 9/32"	brass	countersunk	n.a.
2485-40	3/16" x 3/8"	brass	countersunk	0.20
0306	3/16" x 5/16"	steel	round head	0.50
R0308	3/16" x 9/16"	steel	round head	0.35
0314	3/16" x 3/8"	steel	truss head	1.00

Cotter Pins

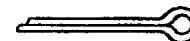

R551	3/64" x 9/16"	zinc	0.20
R0290P	1/16" x 1/2"	park	0.19
R0290	1/16" x 1/2"	zinc	0.15
R0296	1/16" x 5/8"	zinc	0.15
R0297	1/16" x 3/4"	zinc	0.15
R0291P	3/32" x 5/8"	park	0.19
R0291	3/32" x 5/8"	zinc	0.15
R0298	3/32" x 7/8"	zinc	0.15
513	3/32" x 15/16"	zinc	0.60
R0292P	3/32" x 1"	park	0.25
R0292	3/32" x 1"	zinc	0.15
R0293	1/8" x 5/8"	zinc	0.15
R0294	1/8" x 1-1/4"	zinc	0.20
R511	9/64" x 1-1/4"	zinc	0.25
R0295	3/16" x 1"	zinc	0.25



Round head machine screw, zinc

H01044005	4-40 x 1/4"	0.30
H01044007	4-40 x 3/8"	0.30
H01044010	4-40 x 1/2"	0.30
H01044012	4-40 x 5/8"	0.30
H01044015	4-40 x 3/4"	0.30
H01054005	5-40 x 1/4"	0.30
H01054010	5-40 x 1/2"	0.30
H01063205	6-32 x 1/4"	0.30
H01063207	6-32 x 3/8"	0.30
H01063210	6-32 x 1/2"	0.30
H01063212	6-32 x 5/8"	0.30
H01063215	6-32 x 3/4"	0.30
H01063220	6-32 x 1"	0.30
H01063225	6-32 x 1 1/4"	0.30
H01063230	6-32 x 1 1/2"	0.30
H01083205	8-32 x 1/4"	0.30
H01083207	8-32 x 3/8"	0.30
H01083210	8-32 x 1/2"	0.30
H01083212	8-32 x 5/8"	0.30
H01083215	8-32 x 3/4"	0.30
H01083217	8-32 x 7/8"	0.30
H01083220	8-32 x 1"	0.50
H01083225	8-32 x 1 1/4"	0.50
H01083230	8-32 x 1 1/2"	0.50
H01102407	10-24 x 3/8"	0.30
H01102410	10-24 x 1/2"	0.30
H01102412	10-24 x 5/8"	0.30
H01102415	10-24 x 3/4"	0.30
H01102420	10-24 x 1"	0.50
H01102425	10-24 x 1 1/4"	0.50
H01102430	10-24 x 1 1/2"	0.50
H01102435	10-24 x 1 3/4"	0.50
H01102440	10-24 x 2"	0.50
H01103207	10-32 x 3/8"	0.30
H01103210	10-32 x 1/2"	0.30
H01103212	10-32 x 5/8"	0.30
H01103215	10-32 x 3/4"	0.30
H01103220	10-32 x 1"	0.50
H01103225	10-32 x 1 1/4"	0.50
H01103230	10-32 x 1 1/2"	0.50
H01103235	10-32 x 1 3/4"	0.50
H01103240	10-32 x 2"	0.50
H01122407	12-24 x 3/8"	0.30
H01122410	12-24 x 1/2"	0.30
H01122412	12-24 x 5/8"	0.30
H01122415	12-24 x 3/4"	0.30
H01122420	12-24 x 1"	0.50

Flat head machine screw, zinc

H02044007	4-40 x 3/8"	0.30
H02044010	4-40 x 1/2"	0.30
H02044012	4-40 x 5/8"	0.30
H02044015	4-40 x 3/4"	0.30
H02063207	6-32 x 3/8"	0.30
H02063210	6-32 x 1/2"	0.30
H02063212	6-32 x 5/8"	0.30
H02063215	6-32 x 3/4"	0.30
H02063220	6-32 x 1"	0.30
H02083207	8-32 x 3/8"	0.30
H02083210	8-32 x 1/2"	0.30
H02083212	8-32 x 5/8"	0.30
H02083215	8-32 x 3/4"	0.30
H02083220	8-32 x 1"	0.30
H02102410	10-24 x 1/2"	0.30
H02102412	10-24 x 5/8"	0.30
H02102415	10-24 x 3/4"	0.30
H02102420	10-24 x 1"	0.30
H02102425	10-24 x 1 1/4"	0.30
H02103210	10-32 x 1/2"	0.30
H02103212	10-32 x 5/8"	0.30
H02103215	10-32 x 3/4"	0.30
H02103220	10-32 x 1"	0.30
H02103225	10-32 x 1 1/4"	0.30

Flat head sheet metal screws, zinc

H03040007	4 x 3/8"	0.30
H03040010	4 x 1/2"	0.30
H03040012	4 x 5/8"	0.30
H03060007	6 x 3/8"	0.30
H03060010	6 x 1/2"	0.30
H03060012	6 x 5/8"	0.30
H03060015	6 x 3/4"	0.30
H03060020	6 x 1"	0.30
H03080007	8 x 3/8"	0.30
H03080010	8 x 1/2"	0.30
H03080012	8 x 5/8"	0.30
H03080015	8 x 3/4"	0.30
H03080020	8 x 1"	0.30
H03100010	10 x 1/2"	0.30
H03100015	10 x 3/4"	0.30
H03100020	10 x 1"	0.30
H03100025	10 x 1 1/4"	0.30
H03120010	12 x 1/2"	0.30
H03120015	12 x 3/4"	0.30
H03120020	12 x 1"	0.30
H03140010	14 x 1/2"	0.30
H03140015	14 x 3/4"	0.30
H03140020	14 x 1"	0.30



Pan head sheet metal screws, zinc

H04040007	4 x 3/8"	0.30
H04040010	4 x 1/2"	0.30
H04040012	4 x 5/8"	0.30
H04060007	6 x 3/8"	0.30
H04060010	6 x 1/2"	0.30
H04060012	6 x 5/8"	0.30
H04060015	6 x 3/4"	0.30
H04060020	6 x 1"	0.30
H04080007	8 x 3/8"	0.30
H04080010	8 x 1/2"	0.30
H04080012	8 x 5/8"	0.30
H04080015	8 x 3/4"	0.30
H04080020	8 x 1"	0.30
H04100010	10 x 1/2"	0.30
H04100012	10 x 5/8"	0.30
H04100015	10 x 3/4"	0.30
H04100020	10 x 1"	0.30
H04100025	10 x 1 1/4"	0.30
H04120010	12 x 1/2"	0.30
H04120015	12 x 3/4"	0.30
H04120020	12 x 1"	0.30
H04140010	14 x 1/2"	0.30
H04140015	14 x 3/4"	0.30
H04140020	14 x 1"	0.30



Hex head bolt, stainless steel

H06142012	1/4-20 x 5/8"	1.50
H06142015	1/4-20 x 3/4"	1.50
H06142017	1/4-20 x 7/8"	1.50
H06142020	1/4-20 x 1"	1.50
H06142025	1/4-20 x 1-1/4"	1.70
H06142030	1/4-20 x 1-1/2"	1.70
H06142035	1/4-20 x 1-3/4"	1.70
H06142040	1/4-20 x 2"	1.70
H06142045	1/4-20 x 2-1/4"	1.70
H06142812	1/4-28 x 5/8"	1.50
H06142815	1/4-28 x 3/4"	1.50
H06142817	1/4-28 x 7/8"	1.50
H06142820	1/4-28 x 1"	1.50
H06142825	1/4-28 x 1-1/4"	1.70
H06142830	1/4-28 x 1-1/2"	1.70
H06142835	1/4-28 x 1-3/4"	1.70
H06142840	1/4-28 x 2"	1.70

H06142845	1/4-28 x 2-1/4"	1.70
H06161812	5/16-18 x 5/8"	1.50
H06161815	5/16-18 x 3/4"	1.50
H06161817	5/16-18 x 7/8"	1.50
H06161820	5/16-18 x 1"	1.50
H06161825	5/16-18 x 1-1/4"	1.70
H06161830	5/16-18 x 1-1/2"	1.70
H06161835	5/16-18 x 1-3/4"	1.70
H06161840	5/16-18 x 2"	1.70
H06161845	5/16-18 x 2-1/4"	1.70
H06162412	5/16-24 x 5/8"	1.50
H06162415	5/16-24 x 3/4"	1.50
H06162417	5/16-24 x 7/8"	1.50
H06162420	5/16-24 x 1"	1.50
H06162425	5/16-24 x 1-1/4"	1.70
H06162430	5/16-24 x 1-1/2"	1.70
H06162435	5/16-24 x 1-3/4"	1.70

H06162440	5/16-24 x 2"	1.70
H06162445	5/16-24 x 2-1/4"	1.70
H06181615	3/8-16 x 3/4"	1.50
H06181620	3/8-16 x 1"	1.50
H06181625	3/8-16 x 1-1/4"	1.70
H06181630	3/8-16 x 1-1/2"	1.70
H06181635	3/8-16 x 1-3/4"	1.70
H06181640	3/8-16 x 2"	1.70
H06182415	3/8-24 x 3/4"	1.50
H06182420	3/8-24 x 1"	1.50
H06182425	3/8-24 x 1-1/4"	1.70
H06182430	3/8-24 x 1-1/2"	1.70
H06182435	3/8-24 x 1-3/4"	1.70
H06182440	3/8-24 x 2"	1.70



Standard Hardware

Hex head bolt, zinc

H07142010	1/4-20 x 1/2"	0.50	H07162417	5/16-24 x 7/8"	0.50	H07182470	3/8-24 x 3-1/2"	0.80
H07142012	1/4-20 x 5/8"	0.50	H07162420	5/16-24 x 1"	0.50	H07182475	3/8-24 x 3-3/4"	0.80
H07142015	1/4-20 x 3/4"	0.50	H07162425	5/16-24 x 1-1/4"	0.50	H07201415	7/16-14 x 3/4"	1.30
H07142017	1/4-20 x 7/8"	0.50	H07162430	5/16-24 x 1-1/2"	0.50	H07201420	7/16-14 x 1"	1.30
H07142020	1/4-20 x 1"	0.50	H07162435	5/16-24 x 1-3/4"	0.70	H07201425	7/16-14 x 1-1/4"	1.30
H07142025	1/4-20 x 1-1/4"	0.50	H07162440	5/16-24 x 2"	0.70	H07201430	7/16-14 x 1-1/2"	1.30
H07142030	1/4-20 x 1-1/2"	0.50	H07162445	5/16-24 x 2-1/4"	0.70	H07201435	7/16-14 x 1-3/4"	1.60
H07142035	1/4-20 x 1-3/4"	0.70	H07162450	5/16-24 x 2-1/2"	0.70	H07201440	7/16-14 x 2"	1.60
H07142040	1/4-20 x 2"	0.70	H07162455	5/16-24 x 2-3/4"	0.70	H07201445	7/16-14 x 2-1/4"	1.60
H07142045	1/4-20 x 2-1/4"	0.70	H07181610	3/8-16 x 1/2"	0.70	H07201450	7/16-14 x 2-1/2"	1.60
H07142050	1/4-20 x 2-1/2"	0.70	H07181612	3/8-16 x 5/8"	0.70	H07201455	7/16-14 x 2-3/4"	1.60
H07142055	1/4-20 x 2-3/4"	0.70	H07181615	3/8-16 x 3/4"	0.70	H07202015	7/16-20 x 3/4"	1.30
H07142810	1/4-28 x 1/2"	0.50	H07181617	3/8-16 x 7/8"	0.70	H07202020	7/16-20 x 1"	1.30
H07142812	1/4-28 x 5/8"	0.50	H07181620	3/8-16 x 1"	0.80	H07202025	7/16-20 x 1-1/4"	1.30
H07142815	1/4-28 x 3/4"	0.50	H07181625	3/8-16 x 1-1/4"	0.80	H07202030	7/16-20 x 1-1/2"	1.30
H07142817	1/4-28 x 7/8"	0.50	H07181630	3/8-16 x 1-1/2"	0.80	H07202035	7/16-20 x 1-3/4"	1.60
H07142820	1/4-28 x 1"	0.50	H07181635	3/8-16 x 1-3/4"	0.80	H07202040	7/16-20 x 2"	1.60
H07142825	1/4-28 x 1-1/4"	0.50	H07181640	3/8-16 x 2"	0.80	H07202045	7/16-20 x 2-1/4"	1.60
H07142830	1/4-28 x 1-1/2"	0.50	H07181645	3/8-16 x 2-1/4"	0.80	H07202050	7/16-20 x 2-1/2"	1.60
H07142835	1/4-28 x 1-3/4"	0.70	H07181650	3/8-16 x 2-1/2"	0.80	H07202055	7/16-20 x 2-3/4"	1.60
H07142840	1/4-28 x 2"	0.70	H07181655	3/8-16 x 2-3/4"	0.80	H07202060	7/16-20 x 3"	1.60
H07142845	1/4-28 x 2-1/4"	0.70	H07181660	3/8-16 x 3"	0.80	H07221315	1/2-13 x 3/4"	1.30
H07142850	1/4-28 x 2-1/2"	0.70	H07181665	3/8-16 x 3-1/4"	0.80	H07221320	1/2-13 x 1"	1.30
H07142855	1/4-28 x 2-3/4"	0.70	H07181670	3/8-16 x 3-1/2"	0.80	H07221325	1/2-13 x 1-1/4"	1.30
H07161812	5/16-18 x 5/8"	0.50	H07181675	3/8-16 x 3-3/4"	0.80	H07221330	1/2-13 x 1-1/2"	1.30
H07161815	5/16-18 x 3/4"	0.50	H07182410	3/8-24 x 1/2"	0.70	H07221335	1/2-13 x 1-3/4"	1.60
H07161817	5/16-18 x 7/8"	0.50	H07182412	3/8-24 x 5/8"	0.70	H07221340	1/2-13 x 2"	1.60
H07161820	5/16-18 x 1"	0.50	H07182415	3/8-24 x 3/4"	0.70	H07221345	1/2-13 x 2-1/4"	1.60
H07161825	5/16-18 x 1-1/4"	0.50	H07182417	3/8-24 x 7/8"	0.70	H07221350	1/2-13 x 2-1/2"	1.60
H07161830	5/16-18 x 1-1/2"	0.50	H07182420	3/8-24 x 1"	0.80	H07221355	1/2-13 x 2-3/4"	1.60
H07161835	5/16-18 x 1-3/4"	0.70	H07182425	3/8-24 x 1-1/4"	0.80	H07221360	1/2-13 x 3"	1.60
H07161840	5/16-18 x 2"	0.70	H07182430	3/8-24 x 1-1/2"	0.80	H07221365	1/2-13 x 3-1/4"	1.60
H07161845	5/16-18 x 2-1/4"	0.70	H07182435	3/8-24 x 1-3/4"	0.80	H07222020	1/2-20 x 1"	1.30
H07161850	5/16-18 x 2-1/2"	0.70	H07182440	3/8-24 x 2"	0.80	H07222025	1/2-20 x 1-1/4"	1.30
H07161855	5/16-18 x 2-3/4"	0.70	H07182445	3/8-24 x 2-1/4"	0.80	H07222030	1/2-20 x 1-1/2"	1.30
H07161860	5/16-18 x 3"	0.70	H07182450	3/8-24 x 2-1/2"	0.80	H07222035	1/2-20 x 1-3/4"	1.60
H07162410	5/16-24 x 1/2"	0.50	H07182455	3/8-24 x 2-3/4"	0.80	H07222040	1/2-20 x 2"	1.60
H07162412	5/16-24 x 5/8"	0.50	H07182460	3/8-24 x 3"	0.80	H07222045	1/2-20 x 2 1/4"	1.60
H07162415	5/16-24 x 3/4"	0.50	H07182465	3/8-24 x 3-1/4"	0.80	H07222050	1/2-20 x 2 1/2"	1.60
						H07222055	1/2-20 x 2 3/4"	1.60
						H07222060	1/2-20 x 3"	1.60

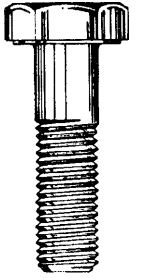

Hex head bolt, chrome plated

H05142012	1/4-20 x 5/8"	1.70	H05161845	5/16-18 x 2 1/4"	2.00	H05201430	7/16-14 x 1-1/2"	2.20
H05142015	1/4-20 x 3/4"	1.70	H05162410	5/16-24 x 1/2"	1.70	H05201435	7/16-14 x 1-3/4"	2.20
H05142017	1/4-20 x 7/8"	1.70	H05162412	5/16-24 x 5/8"	1.70	H05201440	7/16-14 x 2"	2.20
H05142020	1/4-20 x 1"	1.70	H05162415	5/16-24 x 3/4"	1.70	H05202020	7/16-20 x 1"	2.00
H05142025	1/4-20 x 1-1/4"	2.00	H05162417	5/16-24 x 7/8"	1.70	H05202025	7/16-20 x 1-1/4"	2.00
H05142030	1/4-20 x 1-1/2"	2.00	H05162420	5/16-24 x 1"	1.70	H05202030	7/16-20 x 1-1/2"	2.20
H05142035	1/4-20 x 1-3/4"	2.00	H05162425	5/16-24 x 1-1/4"	2.00	H05202035	7/16-20 x 1-3/4"	2.20
H05142040	1/4-20 x 2"	2.00	H05162430	5/16-24 x 1-1/2"	2.00	H05202040	7/16-20 x 2"	2.20
H05142045	1/4-20 x 2-1/4"	2.00	H05162435	5/16-24 x 1-3/4"	2.00	H05221315	1/2-13 x 3/4"	2.00
H05142812	1/4-28 x 5/8"	1.70	H05162440	5/16-24 x 2"	2.00	H05221325	1/2-13 x 1-1/4"	2.00
H05142815	1/4-28 x 3/4"	1.70	H05162445	5/16-24 x 2-1/4"	2.00	H05221330	1/2-13 x 1-1/2"	2.20
H05142817	1/4-28 x 7/8"	1.70	H05181615	3/8-16 x 3/4"	1.70	H05221340	1/2-13 x 2"	2.20
H05142820	1/4-28 x 1"	1.70	H05181620	3/8-16 x 1"	1.70	H05221345	1/2-13 x 2-1/4"	2.20
H05142825	1/4-28 x 1-1/4"	2.00	H05181625	3/8-16 x 1-1/4"	2.00	H05221350	1/2-13 x 2-1/2"	2.20
H05142830	1/4-28 x 1-1/2"	2.00	H05181630	3/8-16 x 1-1/2"	2.00	H05221355	1/2-13 x 2-3/4"	2.20
H05142835	1/4-28 x 1-3/4"	2.00	H05181635	3/8-16 x 1-3/4"	2.00	H05222020	1/2-20 x 1"	2.00
H05142840	1/4-28 x 2"	2.00	H05181640	3/8-16 x 2"	2.00	H05222030	1/2-20 x 1-1/2"	2.20
H05142845	1/4-28 x 2-1/4"	2.00	H05182415	3/8-24 x 3/4"	1.70	H05222035	1/2-20 x 1-3/4"	2.20
H05161812	5/16-18 x 5/8"	1.70	H05182420	3/8-24 x 1"	1.70	H05222040	1/2-20 x 2"	2.20
H05161815	5/16-18 x 3/4"	1.70	H05182425	3/8-24 x 1-1/4"	2.00	H05222045	1/2-20 x 2-1/4"	2.20
H05161817	5/16-18 x 7/8"	1.70	H05182430	3/8-24 x 1-1/2"	2.00	H05222050	1/2-20 x 2-1/2"	2.20
H05161820	5/16-18 x 1"	1.70	H05182435	3/8-24 x 1-3/4"	2.00	H05222055	1/2-20 x 2-3/4"	2.20
H05161825	5/16-18 x 1-1/4"	2.00	H05182440	3/8-24 x 2"	2.00			
H05161830	5/16-18 x 1-1/2"	2.00	H05201420	7/16-14 x 1"	2.00			
H05161835	5/16-18 x 1-3/4"	2.00	H05201425	7/16-14 x 1-1/4"	2.00			
H05161840	5/16-18 x 2"	2.00						

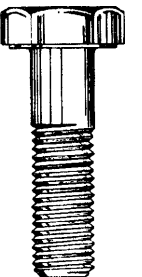

Hex nut, zinc			Hex nuts, chrome			Hex nuts, stainless steel		
H20044005	4-40 x 1/4"	0.20	H24142008	1/4-20 x 7/16"	0.75	H21063206	6-32 x 5/16"	0.50
H20063206	6-32 x 5/16"	0.20	H24142808	1/4-28 x 7/16"	0.75	H21083206	8-32 x 11/32"	0.50
H20083206	8-32 x 11/32"	0.20	H24161810	5/16-18 x 1/2"	0.88	H21102407	10-24 x 3/8"	0.50
H20102407	10-24 x 3/8"	0.20	H24162410	5/16-24 x 1/2"	0.88	H21103207	10-32 x 3/8"	0.50
H20103207	10-32 x 3/8"	0.20	H24181611	3/8-16 x 9/16"	1.00	H21142008	1/4-20 x 7/16"	0.50
H20122408	12-24 x 7/16"	0.20	H24182411	3/8-24 x 9/16"	1.00	H21142808	1/4-28 x 7/16"	0.50
H20142008	1/4-20 x 7/16"	0.20	H24201412	7/16-14 x 5/8"	1.00	H21161810	5/16-18 x 1/2"	0.50
H20142808	1/4-28 x 7/16"	0.20	H24202012	7/16-20 x 5/8"	1.00	H21162410	5/16-24 x 1/2"	0.50
H20161810	5/16-18 x 1/2"	0.20	H24222015	1/2-20 x 3/4"	1.25	H21181611	3/8-16 x 9/16"	0.60
H20162410	5/16-24 x 1/2"	0.20	H24261818	5/8-18 x 15/16"	1.50	H21182411	3/8-24 x 9/16"	0.60
H20181611	3/8-16 x 9/16"	0.30				H21202014	7/16-20 x 11/16"	0.60
H20182411	3/8-24 x 9/16"	0.30				H21222015	1/2-20 x 3/4"	1.00
H20201414	7/16-14 x 11/16"	0.30				H21261818	5/8-18 x 15/16"	2.00
H20202014	7/16-20 x 11/16"	0.30						
H20221315	1/2-13 x 3/4"	0.30						
H20222015	1/2-20 x 3/4"	0.30						
H20261118	5/8-11 x 15/16"	0.30						
H20261818	5/8-18 x 15/16"	0.30						
H20301022	3/4-10 x 1 1/8"	0.30						
H20301622	3/4-16 x 1 1/8"	0.30						

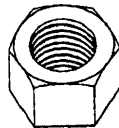



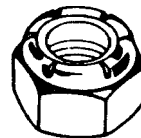

Nylock nuts, zinc			Nylock nuts, chrome		
H22044005	4-40 x 1/4"	0.30	H23102407	10-24 x 3/8"	0.88
H22063206	6-32 x 5/16"	0.30	H23103207	10-32 x 3/8"	0.88
H22083206	8-32 x 11/32"	0.30	H23142008	1/4-20 x 7/16"	1.00
H22102407	10-24 x 3/8"	0.30	H23142808	1/4-28 x 7/16"	0.88
H22103207	10-32 x 3/8"	0.30	H23161810	5/16-18 x 1/2"	1.00
H22122408	12-24 x 7/16"	0.30	H23162410	5/16-24 x 1/2"	1.00
H22142008	1/4-20 x 7/16"	0.30	H23181611	3/8-16 x 9/16"	1.13
H22142808	1/4-28 x 7/16"	0.30	H23182411	3/8-24 x 9/16"	1.13
H22161810	5/16-18 x 1/2"	0.30	H23201412	7/16-14 x 5/8"	1.13
H22162410	5/16-24 x 1/2"	0.40	H23202012	7/16-20 x 5/8"	1.13
H22181611	3/8-16 x 9/16"	0.40	H23222015	1/2-20 x 3/4"	1.25
H22182411	3/8-24 x 9/16"	0.40	H23261818	5/8-18 x 15/16"	1.38
H22201412	7/16-14 x 5/8"	0.40			
H22202012	7/16-20 x 5/8"	0.40			
H22221315	1/2-13 x 3/4"	0.40			
H22222015	1/2-20 x 3/4"	0.40			
H22261118	5/8-11 x 15/16"	0.40			
H22261818	5/8-18 x 15/16"	0.40			
H22301021	3/4-10 x 1 1/16"	0.40			
H22301621	3/4-16 x 1 1/16"	0.40			



Acorn nuts, chrome			Cap nuts, chrome		
H25102407	10-24 x 3/8"	1.63	H26102407	10-24 x 3/8"	1.88
H25103207	10-32 x 3/8"	1.63	H26103207	10-32 x 3/8"	1.88
H25142008	1/4-20 x 7/16"	1.88	H26142008	1/4-20 x 7/16"	1.88
H25142408	1/4-24 x 7/16"	1.88	H26142408	1/4-24 x 7/16"	1.88
H25142808	1/4-28 x 7/16"	1.63	H26142808	1/4-28 x 7/16"	1.63
H25161810	5/16-18 x 1/2"	1.88	H26161810	5/16-18 x 1/2"	1.88
H25162410	5/16-24 x 1/2"	1.88	H26162410	5/16-24 x 1/2"	1.88
H25181611	3/8-16 x 9/16"	2.00	H26181611	3/8-16 x 9/16"	2.13
H25182411	3/8-24 x 9/16"	2.00	H26182411	3/8-24 x 9/16"	2.13
H25201414	7/16-14 x 11/16"	2.50	H26201414	7/16-14 x 11/16"	2.50
H25202014	7/16-20 x 11/16"	2.50	H26202014	7/16-20 x 11/16"	2.50
H25221315	1/2-13 x 3/4"	3.75	H26221315	1/2-13 x 3/4"	3.75
H25222015	1/2-20 x 3/4"	3.75	H26222015	1/2-20 x 3/4"	3.75
H25241217	9/16-12 x 7/8"	4.00	H26241217	9/16-12 x 7/8"	4.00
H25241817	9/16-18 x 7/8"	4.00	H26241817	9/16-18 x 7/8"	4.00
H25261118	5/8-11 x 15/16"	5.63	H26261118	5/8-11 x 15/16"	5.63
H25261125	5/8-11 x 1 1/4"	8.13	H26261818	5/8-18 x 15/16"	5.63
H25261818	5/8-18 x 15/16"	6.88			
H25261825	5/8-18 x 1 1/4"	9.63			
H25301622	3/4-16 x 1 1/8"	7.75			

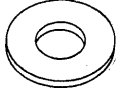
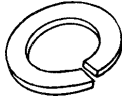

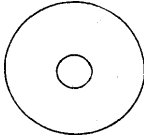
Standard Hardware

Standard flatwasher, zinc			Standard flatwasher, chrome			Flatwasher, stainless steel		
H40042002	4 x 5/16" x 1/32"	0.20	H41082802	8 x 7/16" x 1/32"	0.30	H45082402	8 x 3/8" x 1/32"	0.30
H40062403	6 x 3/8" x 3/64"	0.20	H41103202	10 x 1/2" x 1/32"	0.30	H45102803	10 x 7/16" x 3/64"	0.30
H40082804	8 x 7/16" x 1/16"	0.20	H41123604	12 x 9/16" x 1/16"	0.30	H45144004	1/4" x 5/8" x 1/16"	0.30
H40103203	10 x 1/2" x 3/64"	0.20	H41143603	1/4" x 9/16" x 3/64"	0.38	H45164404	5/16" x 11/16" x 1/16"	0.30
H40123604	12 x 9/16" x 1/16"	0.20	H41164004	5/16" x 5/8" x 1/16"	0.38	H45185204	3/8" x 13/16" x 1/16"	0.30
H40144004	1/4" x 5/8" x 1/16"	0.20	H41184804	3/8" x 3/4" x 1/16"	0.38	H45206004	7/16" x 15/16" x 1/16"	0.30
H40164404	5/16" x 11/16" x 1/16"	0.20	H41244806	7/16" x 3/4" x 3/32"	0.38	H45226804	1/2" x 1-1/16" x 1/16"	0.30
H40185204	3/8" x 13/16" x 1/16"	0.20				H45268404	5/8" x 1-5/16" x 1/16"	0.30
H40206005	7/16" x 15/16" x 5/64"	0.20						
H40226805	1/2" x 1-1/16" x 5/64"	0.20						
Standard lockwasher, zinc			Standard lockwasher, chrome			Lockwasher, stainless steel		
H50041202	4 x 3/16" x 1/32"	0.20	H53081803	8 x 9/32" x 3/64"	0.30	H55081802	8 x 9/32" x 1/32"	0.30
H50061602	6 x 1/4" x 1/32"	0.20	H53102003	10 x 5/16" x 3/64"	0.30	H55102003	10 x 5/16" x 3/64"	0.30
H50081803	8 x 9/32" x 3/64"	0.20	H53143004	1/4" x 15/32" x 1/16"	0.30	H55143004	1/4" x 15/32" x 1/16"	0.30
H50102103	10 x 21/64" x 3/64"	0.20	H53163605	5/16" x 9/16" x 5/64"	0.30	H55163605	5/16" x 9/16" x 5/64"	0.30
H50122404	12 x 3/8" x 1/16"	0.20	H53184306	3/8" x 43/64" x 3/32"	0.30	H55184406	3/8" x 11/16" x 3/32"	0.30
H50143104	1/4" x 31/64" x 1/16"	0.20	H53204807	7/16" x 3/4" x 7/64"	0.30	H55204807	7/16" x 3/4" x 7/64"	0.30
H50163605	5/16" x 9/16" x 5/64"	0.20	H53225508	1/2" x 55/64" x 1/8"	0.30	H55225408	1/2" x 27/32" x 1/8"	0.30
H50184307	3/8" x 43/64" x 7/64"	0.20	H53266710	5/8" x 1-3/64" x 5/32"	0.30	H55266709	5/8" x 1-3/64" x 9/64"	0.30
H50204908	7/16" x 49/64" x 1/8"	0.20						
H50225509	1/2" x 55/64" x 9/64"	0.20						
H50246008	9/16" x 15/16" x 1/8"	n.a.						
H50266710	5/8" x 1-3/64" x 5/32"	0.20						
H50308012	3/4" x 1-1/4" x 3/16"	0.20						
External lockwasher, zinc			Internal lockwasher, zinc					
H51040000	# 4	0.20	H52040000	# 4	0.20			
H51060000	# 6	0.20	H52060000	# 6	0.20			
H51080000	# 8	0.20	H52080000	# 8	0.20			
H51100000	#10	0.20	H52100000	#10	0.20			
H51120000	#12	0.20	H52120000	#12	0.20			
H51140000	1/4"	0.20	H52140000	1/4"	0.20			
H51160000	5/16"	0.20	H52160000	5/16"	0.20			
H51180000	3/8"	0.20	H52180000	3/8"	0.20			
H51200000	7/16"	0.20	H52200000	7/16"	0.20			
			H52220000	1/2"	0.20			
			H52260000	5/8"	0.20			
			H52280000	11/16"	0.20			
			H52300000	3/4"	0.20			
AN flatwasher (small O.D.), zinc			Hardened flatwasher, chrome			Fender washer (large O.D.), zinc		
H42062002	6 x 5/16" x 1/32"	0.20	H46143906	1/4" x 39/64" x 3/32"	0.80	H44106404	10 x 1" x 1/16"	0.20
H42082402	8 x 3/8" x 1/32"	0.20	H46164306	5/16" x 43/64" x 3/32"	0.80	H44146404	1/4" x 1" x 1/16"	0.20
H42102804	10 x 7/16" x 1/16"	0.20	H46185106	3/8" x 51/64" x 3/32"	0.80	H44169604	5/16" x 1-1/2" x 1/16"	0.20
H42143204	1/4" x 1/2" x 1/16"	0.20	H46205806	7/16" x 29/32" x 3/32"	0.80	H44189604	3/8" x 1-1/2" x 1/16"	0.20
H42163604	5/16" x 9/16" x 1/16"	0.20	H46226708	1/2" x 1-3/64" x 1/8"	0.80			
H42184004	3/8" x 5/8" x 1/16"	0.20	H46267308	5/8" x 1-9/64" x 1/8"	0.80			
H42204804	7/16" x 3/4" x 1/16"	0.20						
H42225604	1/2" x 7/8" x 1/16"	0.20						
H42267604	5/8" x 1-3/16" x 1/16"	0.20						
	